



Werkstattwagen und Module

- Stabile Metallkonstruktion
- Verwindungssteif und hochbelastbar
- 5 Schubfächer mit Kugelführungen
- Zentralverriegelung mit Zylinderschloss
- Stabiler Schiebegriff
- Lenkrolle, feststellbar
- Entriegelung mit Einhandbedienung
- Kugelgelagerter Vollauszug

Workshop trolley and modules

- Rigid metal construction
- Resisting torsional forces for high loads
- 5 drawers with ball bearings
- Central locking with cylinder lock
- Strong handle
- Steering roller with brake
- Single-handed unlocking
- Fully extendable drawers with ball bearings

Weitere Informationen
zum Produkt siehe Seite 78-90

For further product information
see page 78-90



Werkstattwagen
und Module

Workshop trolley
and modules

Servante d'atelier
et modules

Carros de taller
y módulos

5081129

Werkstattwagen, leer

In stabiler Metallkonstruktion, verwindungssteif und hochbelastbar, 5 Schubfächer mit Kugelführungen inkl. großem Staufach für Geräte, Maschinen u.ä.. Zentralverriegelung mit Zylinderschloss

Workshop trolley, empty

Rigid metal construction resisting torsional forces, for high loads, 5 drawers with ball bearings and large storage room for machines and equipment. Central locking with cylinder lock

Servante d'atelier, vides

De construction métallique robuste, haute résistance et grande capacité de charge, 5 tiroirs avec glissières à billes y compris grand casier pour outils, machines etc.. Verrouillage central avec serrure à cylindre

Carro de herramientas, vacío

Sólida construcción en chapa metálica, rígida y resistente, 5 cajones con guías sobre rodamientos, con amplio espacio para aparatos voluminosos, máquinas etc.. Cierre central con cerradura

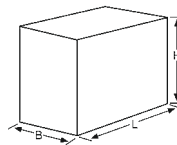

Zubehör siehe gültige HEYCO Preisliste Art.-No. 1129-8-1 bis 12
Accessories please see the actual HEYCO pricelist art no. 1129-8-1 to 12
Accessoires, voir Heyco liste de prix actuelle art. no. 1129-8-1 à 12
Accesorios, por favor, ver lista actual de precios HEYCO, artículo nr. 1129-8-1 al 12

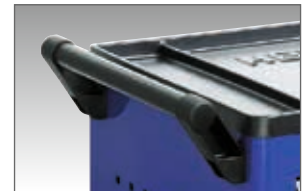
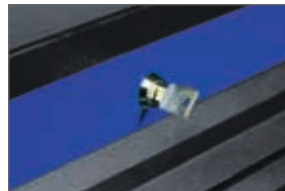

Bestell-No./Order-No.	Art. No.	Maße · Dimensions · Medidas		
50811290120	5081129	(L) 600 x (B) 440 x (H) 950 mm	54000	1

5081130

Werkstattwagen, leer

In stabiler Metallkonstruktion, verwindungssteif und hochbelastbar, 8 Schubfächer mit Kugelführungen inkl. großem Staufach für Geräte, Maschinen u.ä.. Zentralverriegelung mit Zylinderschloss.

Workshop trolley, empty

Rigid metal construction, torsion resistant, for high loads 8 drawers with ball bearings and large storage room for machines and equipment. Central locking with cylinder lock.

Servante d'atelier, vides

De construction métallique robuste, haute résistance et grande capacité de charge, 8 tiroirs avec glissière à billes y compris grand casier pour outils, machines etc.. Verrouillage central avec serrure à cylindre.

Carro de herramientas, vacío

Sólida construcción en chapa metálica, rígida y resistente, 8 cajones con guías sobre rodamientos, con amplio espacio para aparatos voluminosos, máquinas etc.. Cierre central con cerradura.



Zubehör siehe gültige HEYCO Preisliste Art.-No. 1129-8-1 bis 12
Accessories please see the actual HEYCO pricelist art no. 1129-8-1 to 12
Accessoires, voir Heyco liste de prix actuelle art. no. 1129-8-1 à 12
Accesorios, por favor, ver lista actual de precios HEYCO, artículo nr. 1129-8-1 al 12



Bestell-No./Order-No.	Art. No.	Maße · Dimensions · Medidas		
50811300120	5081130	(L) 600 x (B) 440 x (H) 950 mm	60000	1

5081129-26

Werkstattwagen mit Modulen

106-tlg. in 2 Modulen

Workshop trolley with modules

106 pcs. in 2 modules

Servante d'atelier avec modules

106 pcs. en 2 modules

Carro de herramientas con módulos

106 pzs. en 2 módulos



5081129

Details siehe Seite 83-90
 Deatils see page 83-90
 Presentoirs voir page 83-90
 Expositores, véase página 83-90



M 50829-50



M 50829-51

Bestell-No./Order-No.	Art. No.	Module - Modules - Módulos			
50811292600	5081129-26	M 50829-50	M 50829-51	63210	1

5081129-25

Werkstattwagen mit Modulen

90-tlg. in 5 Modulen

Workshop trolley with modules

90 pcs. in 5 modules

Servante d'atelier avec modules

90 pcs. en 5 modules

Carro de herramientas con módulos

90 pzs. en 5 módulos



M 50829-3



M 50829-12



M 50829-13



M 50829-4



M 50829-14

5081129

Details siehe Seite 83-90
 Deatils see page 83-90
 Presentoirs voir page 83-90
 Expositores, véase página 83-90

Bestell-No./Order-No.	Art. No.	Module - Modules - Módulos				
50811292500	5081129-25	M 50829-3	M 50829-4	M 50829-12	64900	1
		M 50829-13	M 50829-14			

5081129-28

Werkstattwagen mit Modulen

100-tlg. in 8 Modulen

Workshop trolley with modules

100 pcs. in 8 modules

Servante d'atelier avec modules

100 pcs. en 8 modules

Carro de herramientas con módulos

100 pzs. en 8 módulos



5081129

Details siehe Seite 83-90
Deatils see page 83-90
Presentoirs voir page 83-90
Expositores, véase página 83-90



M 50829-13



M 50829-14



M 50829-5



M 50829-15



M 50829-8



M 50829-16



M 50829-4



M 50829-12

Bestell-No./Order-No.	Art. No.	Module · Modules · Módulos			g	1
50811292800	5081129-28	M 50829-4	M 50829-5	M 50829-8	66910	1
		M 50829-12	M 50829-13	M 50829-14		
		M 50829-15	M 50829-16			

5081129-27

Werkstattwagen mit Modulen

132-tlg. in 4 Modulen

Workshop trolley with modules

132 pcs. in 4 modules

Servante d'atelier avec modules

132 pcs. en 4 modules

Carro de herramientas con módulos

132 pzs. en 4 módulos



5081129

Details siehe Seite 83-90
Deatils see page 83-90
Presentoirs voir page 83-90
Expositores, véase página 83-90



M 50829-50



M 50829-54



M 50829-51



M 50829-56

Bestell-No./Order-No.	Art. No.	Module · Modules · Módulos		g	1
50811292700	5081129-27	M 50829-50	M 50829-51	69580	1
		M 50829-54	M 50829-56		

5081130-26

Werkstattwagen mit Modulen

106-tlg. in 2 Modulen

Workshop trolley with modules

106 pcs. in 2 modules

Servante d'atelier avec modules

106 pcs. en 2 modules

Carro de herramientas con módulos

106 pzs. en 2 módulos



5081130

Details siehe Seite 83-90
Deatils see page 83-90
Presentoirs voir page 83-90
Expositores, véase página 83-90



M 50829-50



M 50829-51

Bestell-No./Order-No.	Art. No.	Module - Modules - Módulos			
50811302600	5081130-26	M 50829-50	M 50829-51	63800	1

5081130-27

Werkstattwagen mit Modulen

132-tlg. in 4 Modulen

Workshop trolley with modules

132 pcs. in 4 modules

Servante d'atelier avec modules

132 pcs. en 4 modules

Carro de herramientas con módulos

132 pzs. en 4 módulos



5081130

Details siehe Seite 83-90
Deatils see page 83-90
Presentoirs voir page 83-90
Expositores, véase página 83-90



M 50829-50



M 50829-54



M 50829-51



M 50829-56

Bestell-No./Order-No.	Art. No.	Module - Modules - Módulos			
50811302700	5081130-27	M 50829-50 M 50829-54	M 50829-51 M 50829-56	70180	1

Werkstattswagen Zubehör

Zubehör siehe gültige HEYCO
Preisliste Art.-No. 1129-8-1 bis 12

Workshop trolley accessories

Accessories please see the actual
HEYCO pricelist art no.
1129-8-1 to 12

Servante d'atelier accessoires

Accessoires, voir Heyco liste de
prix actuelle art. no.
1129-8-1 à 12

Carros de taller accesorios

Accesorios, por favor, ver lista
actual de precios HEYCO,
artículo nr. 1129-8-1 al 12



Papierkorb
Waste-paper basket
Corbeille à papier
Papelería

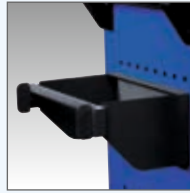

Papierrollenhalter
Paper roll holder
Support de rouleau de
papier
Sujeción para rollo de
papel



Trennblech / Satz
Divider set for drawers
Jeu de lamelles intercalaires
Juego de chapitas separa-
radoras



Fachteiler / Satz
Slotted divider set for drawers
Jeu de castiers de rangement
Juego de divisiones

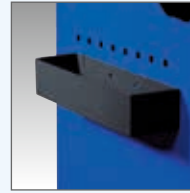

Ablageschale
Storage box
Boîte de rangement
Bandeja



Dosenhalter
Tin holder
Support pour aérosols
Sujeción de botes

5081129-15

Abdeckhaube für Werkstattwagen

210 D PU Nylon. Preis und
Lieferung ohne Werkstattwagen.

Nylon cover for workshop trolley

Nylon 210 D PU. Precio y sumi-
nistro no incluyen el carro de taller.

Protection pour Servante d'atelier

nylon 210 D PU. Prix et livraison
sans servante d'atelier.

Protección para carro de taller

Nylon 210 D PU. Price and
delivery exclusive of tool trolley.



Bestell-No./Order-No.	Art. No.	Maße · Dimensions · Medidas		
50811291500	5081129-15	(L) 730 x (B) 500 x (H) 850 mm	345	1

1128-8-5

Adapterset / Einlegetrennleisten

für HEYCO Werkstattwagen
1127 + 1128 zur Anpassung an
HEYTEC Schaumstoffmodule, 6-tlg.

Adaptor set / separation profiles

for HEYCO workshop trolleys
1127 + 1128 for adaptation to
HEYTEC-Foam modules, 6 pcs.

Assortiment d'adaptateurs/ sectionneurs

pour servantes d'atelier HEYCO
1127 + 1128, pour l'adaptation
des modules en mousse HEYTEC,
6 pcs.

Juego de adaptadores/ listones separadores

para carro de taller HEYCO
1127 + 1128, para adaptar a los
módulos de poliuretano HEYTEC,
6 pzs.

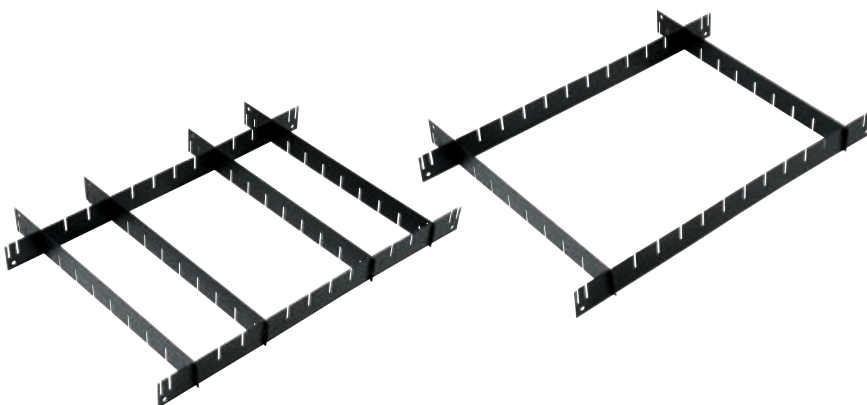

Bestell-No./Order-No.	Art. No.	Maße · Dimensions · Medidas		
01128110200	1128-8-5	560 x 410 x 45 mm	1410	1

Variable Bestückung der Schubladen im Werkstattwagen HEYTEC 5081129/5081130 mit Modulen

Hochwertiger 2-K Schaumstoff

Variable assembly alternatives with modules for workshop trolley HEYTEC 5081129/5081130

High grade 2 components foam material

Equipement des tiroirs de la servante d'atelier HEYTEC 5081129/5081130 avec modules

Garniture 2-K en mousse de haute qualité

Equipamiento de cajones del carro de taller HEYTEC 5081129/5081130 con módulos

Plástico expandido de calidad 24K

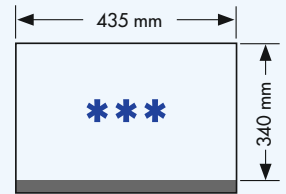
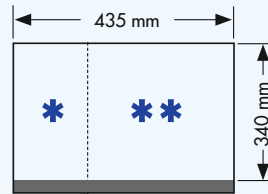
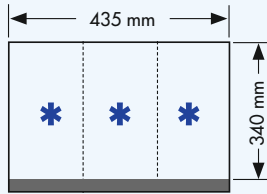

**Modul * *
M 50829-4**

Ringmaulschlüssel-Satz, 17-tlg.

Mit Schonprofil, Doppelmodul

Combination wrenches set, 17 pcs.

With SP-profile, double modul

Jeu de clés mixtes, 17 pcs.

Avec profil de protection, module double

Juego de 17 llaves combinadas

Con perfil especial SP, módulo doble



enthaltend/containing/composition/contenido



MM 6/7/8/9/10/11/12/13/14/
15/16/17/18/19/20/21/22

Bestell-No./Order-No.	Art. No.	Maße · Dimensions · Medidas		
5082900480	M 50829-4	340 x 290 x 40 mm	4400	1

**Modul * *
M 50829-3**

Doppelmaulschlüssel-Satz, 10-tlg.

Double open ended jaw wrenches set, 10 pcs.

Jeu de clés à fourche, 10 pcs.

Juego de 10 llaves fijas de boca abierta



enthaltend/containing/composition/contenido



MM 8x9 / 10x11 / 12x13 / 14x15 /
16x17 / 18x19 / 20x22 / 21x23 /
24x27 / 30x32

Bestell-No./Order-No.	Art. No.	Maße · Dimensions · Medidas		
5082900380	M 50829-3	340 x 145 x 40 mm	1832	1

**Modul *
M 50829-16**



Doppelringschlüssel-
Satz, 8-tlg.

Tief gekröpft, mit Schonprofil

Double ended ring
wrenches set, 8 pcs.

Deep offset, profile saver

Clés polygonales
coudées, 8 pcs.

Avec profil de protection des têtes
de vis

Llaves boca estrella
acodadas, 8 pzs.

Codo profundo, dentado con
perfil SP



enthaltend/containing/composition/contenido



MM 6x7 / 8x9 /
10x11 / 12x13 /
14x15 / 16x17 /
18x19 / 20x22

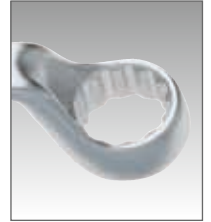

Bestell-No./Order-No.	Art. No.	Maße · Dimensions · Medidas		
50829001680	M 50829-16	340 x 145 x 40 mm	1250	1

**Modul *
M 50829-2**

Knarren-Ringmaul-
schlüssel-Satz
umschaltbar, 13-tlg.



Combination ratchet
wrenches set, reversible,
13 pcs.

Jeu de clés mixtes à
cliquet réversible,
13 pcs.

Juego de llaves
combinadas con carraca
reversible, 13 pzs.

enthaltend/containing/composition/contenido



MM 8/10/12/13/
14/15/16/17/19/22



1/4" / 3/8" / 1/2"



Bestell-No./Order-No.	Art. No.	Maße · Dimensions · Medidas		
50829000280	M 50829-2	340 x 145 x 40 mm	1536	1

**Modul *
M 50829-9**

Knarren-Ringmaul-
schlüssel-Satz, 13-tlg.



Combination ratchet
wrenches set, 13 pcs.

Jeu de clés mixtes à
cliquet, 13 pcs.

Juego de llaves combina-
das con carraca, 13 pzs.

enthaltend/containing/composition/contenido



MM 8/9/10/12/13/
14/15/16/17/19



1/4" / 3/8" / 1/2"



Bestell-No./Order-No.	Art. No.	Maße · Dimensions · Medidas		
50829000980	M 50829-9	340 x 145 x 40 mm	1319	1

**Modul *
M 50829-13**



Betätigungswerkzeug-
Satz, 7-tlg.



Accessories set,
7 pcs.

Jeu d'accessoires,
7 pcs.

Juego de 7 accesorios
de accionamiento

enthaltend/containing/composition/contenido



250 mm



250 mm



125 mm



75 mm



MM 16/20,8

Bestell-No./Order-No.	Art. No.	Maße · Dimensions · Medidas		
50829001383	M 50829-13	340 x 145 x 40 mm	1670	1

**Modul *
M 50829-12**



Steckschlüssel-Satz,
20-tlg.

Socket set,
20 pcs.

Jeu de douilles,
20 pcs.

Juego de llaves de vaso,
20 pzs.



enthaltend/containing/composition/contenido

- \ominus L \rightarrow 40 mm MM 10/11/12/13/14/15/16/17/18/19/20/21/22/24/27/30/32
- \ominus L \rightarrow 75 mm MM 13/17/19

Bestell-No./Order-No.	Art. No.	Maße · Dimensions · Medidas		
50829001283	M 50829-12	340 x 145 x 40 mm	1974	1

**Modul *
M 50829-10**



VDE-Schraubendreher-Satz mit 2K-Griff, 6-tlg.

VDE-Screwdriver set,
6 pcs. with 2 components plastic handles

Jeu de tournevis VDE avec poignée à 2 composantes, 6 pcs.

Juego de destornilladores VDE, 6 pzs., con mango de dos componentes

Nach IEC 60900, DIN 7437 u. DIN 7438 PZ, mit umspritzter Klingenisolierung

Complying with IEC 60900, DIN 7437 and DIN 7438 PZ, insulation of blade and handle injection moulded as one unit

Conforme aux spécifications IEC 60900 : DIN 7437 et DIN 7438 PZ, avec isolation de la lame par injection

Homologados según normas IEC 60900, DIN 7437 y DIN 7438 PZ, varillas con aislamiento inyectado

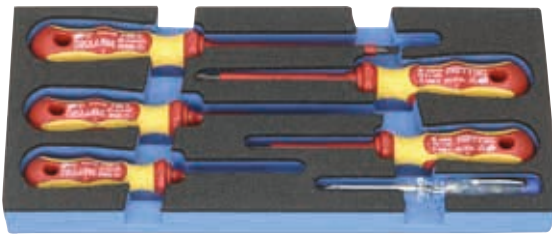

enthaltend/containing/composition/contenido

- 150 - 250 V
- \ominus MM 2,5x75 / 4x100 / 5,5x125
- \oplus PZ 1 / PZ 2

Bestell-No./Order-No.	Art. No.	Maße · Dimensions · Medidas		
50829001033	M 50829-10	340 x 145 x 40 mm	583	1

**Modul *
M 50829-14**



Steckschlüssel-Satz,
36-tlg.

Socket set, 36 pcs.

Jeu de douilles, 36 pcs.

Juego de llaves de vaso,
36 pzs.



enthaltend/containing/composition/contenido

- 150 mm
- 150 mm
- 50 + 100 mm
- 37 mm
- \ominus L \rightarrow 25 mm MM 4/4,5/5/6/7/8/ 9/10/11/12/13
- \ominus L \rightarrow 50 mm MM 6/7/8/9/10/ 11/12/13
- PZ 1 / PZ 2
- 3/4/5/6
- 0,8x4 / 1x5,5
- TT15 / TT20 / TT25 / TT30

Bestell-No./Order-No.	Art. No.	Maße · Dimensions · Medidas		
50829001483	M 50829-14	340 x 145 x 40 mm	1025	1

**Modul *
M 50829-17**



Schraubendrehereinsatz | Screwdriver socket set,
Sortiment, 24-tlg. | 24 pcs.

Composition de douilles-
tournevis, 24 pces. | Conjunto de llaves de
vaso con destornillador,
24 pzs.



enthaltend/containing/composition/contenido		
CL	62 mm	5/6/7/8/10/12/14/17
CL	62 mm	T 25/27/30/40/45/50/55/60
CL	100 mm	6/8/10/12
CL	100 mm	T 30/40/50/60

Bestell-No./Order-No.	Art. No.	Maße · Dimensions · Medidas		
50829001783	M 50829-17	340 x 145 x 40 mm	2525	1

**Modul *
M 50829-11**



Radwechsel-Satz, 5-tlg. | Tools for wheel changing
set, 5 pcs.

Jeu pour écrous de roues,
5 pces. | Juego de herramientas
para cambio de ruedas,
5 pzs.

Bestehend aus 3 Impact-Einsätzen
mit Kugelfangbohrung, inkl.
Kunststoffhülsen zum Schutz von
Alufelgen, Kunststoffschaber

Consisting of 3 impact sockets
with ball retaining groove,
including plastic sleeves for
protecting alloy rims, plastic
scraper

Composé de 3 douilles impact
avec trou pour bille et manchon
plastique de protection des jantes
en aluminium, racloir en plastique

Con 3 llaves de vaso de impacto
con agujero para fijación,
incluidos protectores de plástico
para no dañar llantas de
aluminio, rascador de plástico



enthaltend/containing/composition/contenido		
CL	85 mm	MM 17/19/21
		280 mm
		285 mm

Bestell-No./Order-No.	Art. No.	Maße · Dimensions · Medidas		
50829001100	M 50829-11	340 x 145 x 40 mm	842	1

**Modul *
M 50829-5**

Zangenmodul mit
Schlosserhammer, 3-tlg. | Pliers and hammer set,
3 pcs.

Pince multiprise et pince-
étou, 3 pces. | Juego de 3 pzs.



enthaltend/containing/composition/contenido		
		300 g
		250 mm
		235 mm

Bestell-No./Order-No.	Art. No.	Maße · Dimensions · Medidas		
50829000500	M 50829-5	340 x 145 x 40 mm	1325	1

**Modul *
M 50829-15**

Zangen-Satz, 3-tlg. | Pliers set, 3 pcs.

Jeu de pinces, 3 pces. | Conjunto de 3 alicates

Kombinationszange,
gerade Flachrundzange,
Seitenschneider schwedische
Form, mit Kunststoffhandschutz

Combination plier, snipe nose
plier, diagonal cutting nipper,
with plastic handle

Pince universelle pince à bec
demi-ronds, droite, pince coupante
diagonale modèle suédois, avec
gaine plastique

Alicate universal alicate de radio
recto cortalambres modelo sueco,
con fundas de plástico

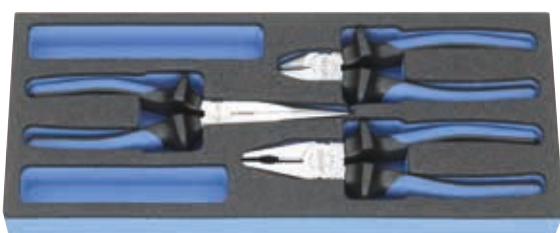

enthaltend/containing/composition/contenido		
		180 mm
		200 mm
		160 mm

Bestell-No./Order-No.	Art. No.	Maße · Dimensions · Medidas		
50829001542	M 50829-15	340 x 145 x 40 mm	715	1

**Modul *
M 50829-8**



Schraubendreher-Satz
mit 2K-Griff, 6-tlg.

Screwdriver set, 6 pcs.

Jeu de tournevis
avec poignée à 2
composantes, 6 pcs.

Juego de destornilladores
con mango de dos
componentes, 6 pzs.

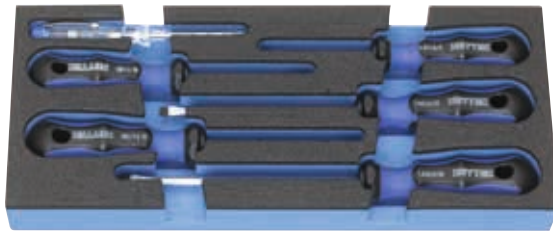

enthaltend/containing/composition/contenido

	150 - 250 V
	MM 4x75 / 5,5x125 / 6,5x150
	PH 1 / PH 2

Bestell-No./Order-No.	Art. No.	Maße · Dimensions · Medidas		
50829000880	M 50829-8	340 x 145 x 40 mm	553	1

**Modul *
M 50829-19**



VDE-Zangen-Satz, 3-tlg.

VDE Pliers set, 3 pcs.

Jeu de pinces VDE,
3 pcs.

Conjunto de 3 alicates,
VDE

Köpfe geschliffen und lackiert,
Griffe mit 2-K Isoliergriffen
IEC 900/DIN EN 60900,
Schneide für mittelharten Draht

Heads ground and lacquered with
2 K insulated handle IEC 900/
DIN EN 60900, cutting edges for
middlehard wire

Chromées et laquées branches
gainées isolées à 2 composantes
IEC 900/DIN EN 60900,
pour fil de dureté moyenne

Cabeza amolada y barnizada,
mangos con fundas aislantes 2K
IEC 900/DIN EN 60900,
cortante para alambre semi-duro



enthaltend/containing/composition/contenido

	180 mm
	200 mm
	160 mm

Bestell-No./Order-No.	Art. No.	Maße · Dimensions · Medidas		
50829001986	M 50829-19	340 x 145 x 40 mm	710	1

Modul *
M 50829-18**



VDE-Werkzeugsortiment,
12-tlg.

VDE Tool set, 12 pcs.

Sélection d'outillage
VDE, 12 pcs.

Conjunto de herramientas
VDE, 12 pzs.

In 2-K Schaumstoffeinlage.
Nach IEC 60900,
DIN 7437 u. DIN 7438 PZ.

With 2 components foam insert.
Complying with IEC 60900,
DIN 7437 and DIN 7438 PZ.

Avec intérieur mousse à 2
composantes. Conforme aux
spécifications IEC 60900 : DIN
7437 et DIN 7438 PZ.

Con material de espuma 2
componentes alta gama. Homologados
según normas IEC 60900, DIN
7437 y DIN 7438 PZ.

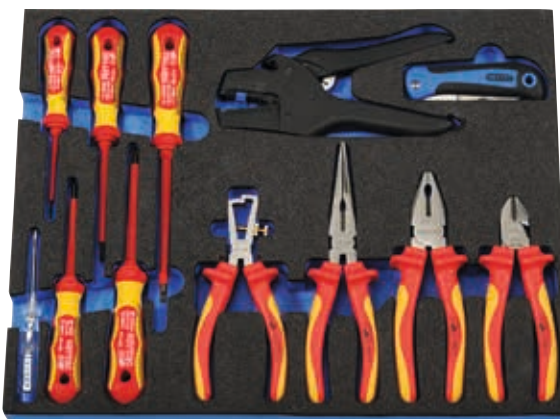

enthaltend/containing/composition/contenido

	180 mm
	160 mm
	200 mm
	160 mm
	200 mm
	115 - 195 mm
	150 - 250 V
	MM 0,5 x 2,5 x 75 / 0,8 x 4,0 x 100 / 1,0 x 5,5 x 125
	PZ 1 / PZ 2

Bestell-No./Order-No.	Art. No.	Maße · Dimensions · Medidas		
50829001800	M 50829-18	435 x 340 x 35 mm	2910	1

Modul *
M 50829-50**

Schlüssel-Satz, 36-tlg.

Mit Schonprofil, Doppelmodul

Combined wrenches set,
36 pcs.

With SP-profile, double modul

Jeu de clés mixtes,
36 pces.

Avec profil de protection, module
double

Juego de 36 llaves
combinadas

Con perfil especial SP, módulo
doble



enthaltend/containing/composition/contenido

	MM 6/7/8/9/10/11/12/13/14/ 15/16/17/18/19/20/21/22/24
	MM 6x7/ 8x9 / 10x11 / 12x13 / 14x15 / 16x17 / 18x19 / 20x22
	MM 6x7 / 8x9 / 10x11 / 12x13 / 14x15 / 16x17 / 18x19 / 20x22 / 24x27
	205 mm / 0 - 30 mm

Bestell-No./Order-No.	Art. No.	Maße · Dimensions · Medidas		
50829005000	M 50829-50	435 x 340 x 35 mm	4500	1

Modul *
M 50829-51**

**Kombinierter Steck-
schlüssel-Satz, 70-tlg.**

Mit Schonprofil, Doppelmodul

Combined socket set,
70 pcs.

Composition de douilles,
70 pces.

Conjunto de llaves de
vaso, 70 pzs.

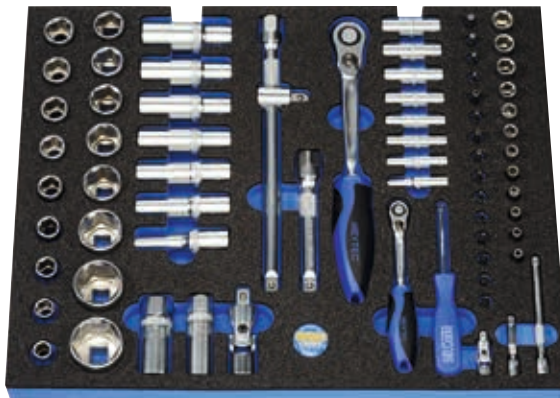

enthaltend/containing/composition/contenido

	150 + 250 mm
	150 mm
	37 + 75 mm
	250 mm
	50 + 100 + 125 mm
\odot L \rightarrow 25 mm \odot 1/4	MM 4/4,5/5/5,5/6/7/ 8/ 9/10/11/12/13
\odot L \rightarrow 50 mm \odot 1/4	MM 6/7/8/9/10/11/12/13
\odot L \rightarrow 40 mm \odot 1/2	MM 10/11/12/13/14/15/16/17/ 18/19/20/21/22/24/27/30/32
\odot L \rightarrow 75 mm \odot 1/2	MM 10/13/14/15/17/19/22
\odot L \rightarrow 65 mm	MM 16/20,8
	PZ 1 / PZ 2
	3/4/5/6
	0,8x4 / 1x5,5
	TT 10/15/20/25/27/30/40

Bestell-No./Order-No.	Art. No.	Maße · Dimensions · Medidas		
50829005100	M 50829-51	435 x 340 x 35 mm	4710	1



Modul *
M 50829-52**

Schraubendrehereinsatz | Screwdriver socket set,
Sortiment, 48-tlg. | 48 pcs.

Composition de douilles-
tournevis, 48 pces. | Conjunto de llaves de
vaso con destornillador,
48 pzs.

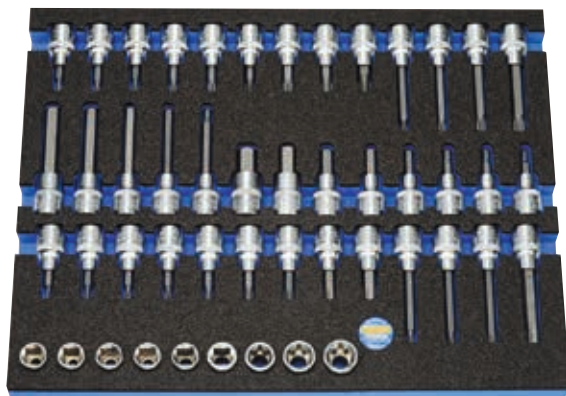

enthaltend/containing/composition/contenido

	CL 62 mm	5/6/7/8/10/12/14/17
	CL 100 mm	6/8/10/12/14
	CL 62 mm	M5 / M6 / M8 / M10
	CL 62 mm	T 20/25/27/30/40/45/50/55/60
	CL 100 mm	M 6/8/10/12
	CL 100 mm	T 30/40/50/60
	CL 38 mm	E 10/11/12/14/16/18/20/22/24
	CL 62 mm	M5 / M6 / M8 / M10 / M12

Bestell-No./Order-No.	Art. No.	Maße · Dimensions · Medidas		
50829005200	M 50829-52	435 x 340 x 35 mm	4630	1

Modul *
M 50829-53**

Steckschlüssel-Satz, | Socket set, 17 pcs.
17-tlg.

Jeu de douilles, 17 pces. | Juego de llaves de vaso,
17 pzs.



enthaltend/containing/composition/contenido

	510 mm	
	455 mm	
	3/4" - 1/2"	
	100 + 200 + 400 mm	
	CL 40 mm	MM 19/22/24/27/30/32/36
	HW 14/17/19/22	

Bestell-No./Order-No.	Art. No.	Maße · Dimensions · Medidas		
50829005300	M 50829-53	435 x 340 x 35 mm	8800	1

Modul *
M 50829-54**

Zangen-Satz, 10-tlg. | Pliers set, 10 pcs.

Jeu de pinces, 10 pces. | Conjunto de 10 alicates



enthaltend/containing/composition/contenido

	250 mm
	230 mm
	260 mm
	235 mm
	200 mm
	180 mm
	200 mm
	160 mm
	Gr. 18 mm inkl. Ersatzklingen / incl. Spare blades

Bestell-No./Order-No.	Art. No.	Maße · Dimensions · Medidas		
50829005400	M 50829-54	435 x 340 x 35 mm	2870	1

Modul *
M 50829-55**

Schraubendreher-Satz
mit 2K-Griff, 35-tlg.

Screwdriver set,
35 pcs.

Jeu de tournevis
avec poignée à 2
composantes, 35 pcs.

Juego de destornilladores
con mango de dos
componentes, 35 pzs.

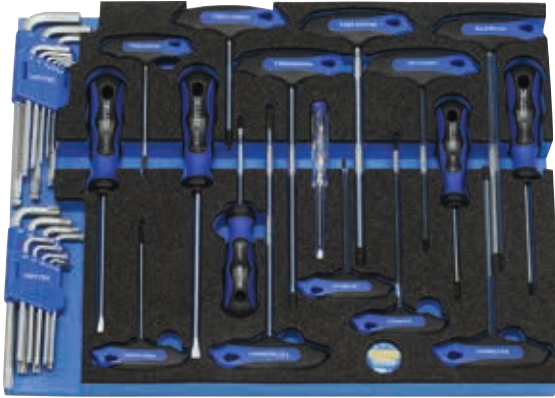

enthaltend/containing/composition/contenido

	150 - 250 V
	MM 4x75 / 5,5x125 / 6,5x150
	PH 1 / PH 2
	T 15/20/25/27/30/40
	MM 8/6/5/4/3
	T 10/15/20/25/27
	30/40/45/50
	MM 1,5/2/2,5/3/ 4/5/6/8/10

Bestell-No./Order-No.	Art. No.	Maße · Dimensions · Medidas		
50829005500	M 50829-55	435 x 340 x 35 mm	1800	1

Modul *
M 50829-56**

Kombinierter Werkzeug-
Satz, 16-tlg.

Combination tool set,
16 pcs.

Ensemble d'outils
combinés, 16 pcs.

Set de herramientas
combinadas, 16 pzs.



enthaltend/containing/composition/contenido

	1000 g
	300 g
	Ø 35
	200 mm
	Ø 3 x 120 mm
	Ø 5 x 150 mm
	Ø 3 x 120 mm
	5 x 130 mm
	12 x 130 mm
	14 x 150 mm

Bestell-No./Order-No.	Art. No.	Maße · Dimensions · Medidas		
50829005600	M 50829-56	435 x 340 x 35 mm	3500	1

Modul *
M 50829-57**

Werkzeug-Satz „KFZ“,
17-tlg.

Vehicle tool set,
17 pcs.

Ensemble d'outils "KFZ",
17 pcs.

Conjunto de herramien-
tas "KFZ", 17 pzs.



enthaltend/containing/composition/contenido

	CL 85 mm	MM 17/19/21
	CL 150 mm	MM 17/19/21
	280 mm	
	400 mm	
	290 mm	
	CL 75 mm	MM 16/20,8
	84 mm	0-60 mm
	260 mm	
	40 - 200 Nm	

Bestell-No./Order-No.	Art. No.	Maße · Dimensions · Medidas		
50829005700	M 50829-57	435 x 340 x 35 mm	4200	1

50868

75 - 77

Werkzeugkoffer
Jagd, Natur, Freizeit

110-tlg. in 3 Modulen

Tool box
Forestry - Nature - Leisure

110 pcs. in 3 modules

Coffret d'outillage
pour la chasse,
la nature et les loisirs

110 pces. en 3 modules

Maleta de
herramientas bosque,
campo, jardín

110 pzs. en 3 módulos

FORESTMAN

Professional Outdoor Toolset



Hochwertige Aluminium-Box

- Verstärkt durch profilierte Sicken
- Witterungs- und temperaturbeständig
- Selbststeinklappender Sicherheitsgriff
- Umlaufende Gummidichtung im Kantenprofil als Schutz vor Staub und Spritzwasser

High-grade Aluminium-box

- Profiled beads for reinforcement
- Resistant to exposure and temperatures
- Self-folding safety handle
- Surrounding rubber sealing in profiled edge for protection against dust and spray

Coffret en aluminium de haute résistance

- Cornières de renforcement
- Résiste aux intempéries et températures
- Poignée de sécurité à rabat automatique
- Caoutchouc d'étanchéité totale pour protéger contre les poussières et projections

Maleta de aluminio de gran calidad

- Con perfil protector en los cantos
- Resistente a la intemperie
- Asa de seguridad, auto-plegable
- Junta de goma en el canto que sella el contenido contra polvo y humedad

50868-1**FORESTMAN**

- 1 Paar Arbeitshandschuhe
- 1 Autolichtprüfer 6 - 24 V
- 1 Sicherheits-Rettungsmesser, Länge 200 mm
- 1 LED-Solar-Stablampe, Länge 180 mm
- 1 Profi-Bandmass, 5 m
- 1 Puk-Handsäge mit 2 Sägeblättern
- 1 Rolle Isolierband, Textilgewebe
- 1 Gartenschere
- 1 20-tlg. Nagelsortiment 4,6 x 130 mm / 3,1 x 65 mm
- 1 Leere Kunststoffbox (für Kleinteile)
- 1 Spannungsprüfer 250 V
- 1 Latthammer, Vollstahl 600 gr.
- 1 Pollerschlüssel, 3-kt, M10 x M12, DIN 3222/3223
- 1 Stirnleuchte mit Batterien

- 1 Pair of working gloves
- 1 Car light tester 6 - 24 V
- 1 Safety-rescue knife, 200 mm long
- 1 LED Solar torch, 180 mm long
- 1 Professional measuring tape, 5 m
- 1 Universal mini hacksaw frame with 2 blades
- 1 Roll of insulating tape, textile fabric
- 1 Pair of garden-shears
- 1 Assortment of 20 pcs. of nails 4,6 x 130 mm / 3,1 x 65 mm
- 1 Empty plastic box for bits and pieces
- 1 Voltage tester 250 V
- 1 All steel carpenters hammer, 600 gr.
- 1 Foldable safety saw
- 1 Triangular wrench for bollards, M10 x M12, DIN 3222/3223
- 1 Headlamp with batteries

- 1 Paire de gants de travail
- 1 Contrôleur de tension 6 - 24 V.
- 1 Coûteau de survie de sécurité, L 200 mm
- 1 Lampe de poche solaire à LED, L 180 mm
- 1 Mètre-ruban professionnel, 5 M
- 1 Mini-scie à découper et 2 lames
- 1 Rouleau de bande isolante en toile textile
- 1 Sécateur de jardin
- 1 Assortiment de clous, 20 pces. (4,6 x 130 mm / 3,1 x 65 mm)
- 1 Boîte plastique vide (pour petites pièces)
- 1 Tournevis détecteur de tension 250 V.
- 1 Marteau de charpentier 600 gr.
- 1 Scie de sécurité repliable
- 1 Clé en tube triangulaire, M10 x M12, DIN 3222/3223
- 1 Lampe à tête avec piles

- 1 Par de guantes de trabajo
- 1 Buscapolos 6 a 24 V
- 1 Navaja de emergencia, largura 200 mm
- 1 linterna LED solar, largo 180 mm
- 1 Flexómetro, 5m
- 1 Miniserra con 2 hojas
- 1 Rollo de cinta aislante
- 1 Tijera de podar
- 1 Surtido de 20 clavos 4,6 x 130 / 3,1 x 65 mm
- 1 Caja de plástico vacía, para piecero
- 1 Buscapolos 250 V
- 1 Martillo de carpintero 600 grs. enteramente de acero
- 1 Sierra plegable, de seguridad
- 1 Llave perfil triangular, M10 x M12, DIN 3222/3223
- 1 linterna de cabeza con pilas

**50868-2****FORESTMAN**

- 1 Zündkerzenschlüssel 13 x 19 für fast alle Motorsägen und -geräte
- 1 Handbeil 600 gr.
- 1 Rohr- und Wasserpumpenzange 240 mm
- 1 Steinmeißel 300 x 18 mm
- 1 Monier- und Rabitzzange 220 mm, isoliert
- 7-tlg. Winkelschraubendreher-Satz, 6-kt, 1,5 - 6 mm
- 7-tlg. Winkelschraubendreher-Satz, TORX, T10 - T40
- 1 Fäustel, Fiberglasstiel, 1.000 gr.
- 1 Einmaulschlüssel, verstellbar 0-25 mm

- 1 Spark plug wrench 13 x 19 for nearly all motor saws and -tools
- 1 Hatchet 600 g
- 1 Pair of multigrip pliers; 240 mm
- 1 Stone chisel, 300 x 18 mm
- 1 Pair of tower pincers
- 1 Set of 7 pcs. of hexagonal head wrenches, 1,5 - 6 mm
- 1 Set of 7 pcs. of "I"-Shaped TORX wrenches, T10 - T40
- 1 Club hammer with fibreglass handle, 1000 gr.
- 1 Adjustable wrench, opening up to 25 mm

- 1 Clé de bougie, presque toutes les outils à moteur thermique
- 1 Hachette 600 gr.
- 1 Pince multiprise 240 mm
- 1 Burin à pierre 300 x 18 mm
- 1 Tenaille russe
- Jeu de clés mâles coudées 6-pans 7 pces, 1,5 - 6 mm
- Jeu de clés mâles coudées TORX, 7 pces, T10 - T40
- 1 Masse, mache en fibre, 1000 gr.
- 1 Clé à molette, réglable 0-25 mm

- 1 Llave de bujía 13 x 19 mm, para prácticamente todo tipo de sierras y aparatos de motor
- 1 Hacha 600 gramos
- 1 Tenaza poliasidora 240 mm
- 1 Cortafrio 300 x 18 mm
- 1 Tenaza rusa, 220 mm, mango plastificado
- 1 Juego de 7 llaves Allen, 1,5 a 6 mm
- 1 Juego de 7 llaves TORX, T10 a T40
- 1 Maceta 1.000 grs., mango de fibra de vidrio
- 1 Llave ajustable 0-25mm

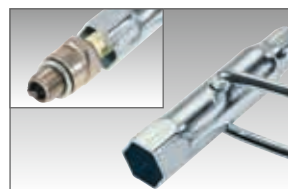

50868-3

FORESTMAN



- 1 Nageleisen
- 1 Steckschlüsselgarnitur 1/4", 22-tlg. MM 5 – 13
- 1 Bit-Box-Satz, 32-tlg.
- 1 Akkuschauber
- 1 Bohrsatz, MM 1–6
- 1 Kabelbinder-Satz 203 x 4,6 mm, 20-tlg.
- 1 Klappspaten, 3-fach verstellbar

- 1 Goose neck ripping bar
- 1 Socket set of 22 pcs., 1/4" sq. drive, MM 5 – 13
- 1 Bit-box-set, 32 pcs.
- 1 cordless screwdriver
- 1 drill set, MM 1–6
- 1 Set of 20 pcs. of cable ties 203 x 4,6 mm
- 1 Foldable spade, adjustable for 3 working positions

- 1 Pince à décoffrer
- 1 Composition de douilles 1/4", MM 5 – 13, 22 pces.
- 1 Jeu d'embouts de 32 pces.
- 1 Tournevis sans fil
- 1 Jeu de forets, MM 1–6
- 1 Jeu de 20 attache-câbles 203 x 4,6 mm
- 1 Pelle pliable à 3 positions

- 1 Desencofrador
- 1 Juego de 22 llaves de vaso 1/4", MM 5 – 13
- 1 Juego de 32 puntas de destornillador en caja
- 1 Destornillador inalámbrico
- 1 Juego de taladro, MM 1–6
- 1 Surtido de 20 tiras para atar cables 203 x 4,6 mm
- 1 Pala plegable, 3 posiciones en ángulo

Steckschlüsselgarnitur 1/4", 22-tlg.

(Art.-Nr. 50829-3017 Seite 42)
Arretierbare Winkelknanne, Steckschlüssel MM 5 – 13, magnetischer Schnellwechsel-adapter, Steckgriff, Verlängerung, Schraubendrehereinsätze Schlitz, Kreuzschlitz, TORX®

Socket set, square drive, 1/4", 22 pcs.

(art.-no. 50829-3017 page 42)
Angled ratchet, lockable in 5 positions, sockets MM 5 – 13, magnetic quick changing adapter, spinner handle, extension, screwdriver sockets for plain slot screws, cross slot screws, TORX® socket screws

Composition de douilles 1/4", 22 pces.

(art.-no. 50829-3017 page 42)
Cliquet angulaire blocable sur 5 positions, douilles MM 5 – 13 adaptateur, magnétique à changement rapide poignée d'entraînement, rallonge douilles-tournevis plat, en croix et TORX®

Conjuntode 1/4", 22 pzs.

(art.-no. 50829-3017 página 42)
Carraca con bloqueo de ángulo en 5 posiciones, llaves de vaso de MM 5 – 13, soporte de cambio rápido, imantado, portadestornillador, alargadera, puntas de destornillador, para tornillos con ranura, Phillips y TORX®

Akkuschauber-Set

3,6 V/1,3 Ah Li-ion Akku, max. Drehmoment 5 Nm, R+L-Lauf, Ladezeit: 300 min., in einer Polyester Tasche mit Reißverschluss, inklusive Ladegerät 220 V und KFZ 12 V

Cordless screwdriver set

3,6 V/1,3 Ah Li-ion Akku, max. torque 5 Nm, right-left driver, charge time: 300 min., in polyester bag with zip, including charger 220 V and car 12 V

Jeu de visseuse sur batterie

Batterie de 3,6 V/1,3 Ah Li-ion, couple maximum 5 Nm, visser + dévisser, temps de charge: 300 min., dans un sachet polyester avec fermeture-éclair, y compris le chargeur 220 V et la voiture 12 V

Conjunto de destornillador eléctrico

Acumulador 3,6 V/1,3 ión Li Ah, par 5 Nm, gira a derecha e izquierda, tiempo de carga: 300 min., en una bolsa de poliéster con cremallera, incluyendo el cargador de 220 V y el coche de 12 V

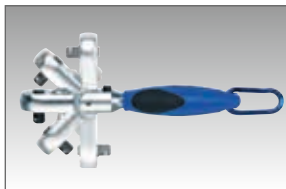

Bestell-No./Order-No.

5086800000

Art. No.

50868

Maße · Dimensions · Medidas

550 x 360 x 240 mm



15100



1



Sonderwerkzeug- und Prototypenbau

Wenn spezielle Anwendungen besondere Werkzeuge oder Werkzeugsortimente erfordern, sind wir Ihr kompetenter Ansprechpartner. Diesen Herausforderungen stellen wir uns und realisieren ökonomisch sinnvolle Werkzeuge und Werkzeugsortimente, technische Lösungen von der Idee bis zur Serienfertigung.

Mit unseren Sortimenten erfüllen wir nicht nur den allgemeinen Werkstattbedarf, sondern sind auch der Spezialist für verlässliche Sortimente im Rettungswesen und in der Flugsicherheit, sowie im Straßenbau und in der Agrartechnik.

Die Verfügbarkeit aller bedeutenden Fertigungsverfahren versetzt uns in die Lage, Ihre Ansprüche und Ideen konsequent und zu Ihrer vollsten Zufriedenheit umzusetzen.

Specialised tools and prototyping

We are the professional partner you need at your side whenever special applications require specialised tools or tool sets. We take on these challenges and realise practical and cost-effective tools, tool portfolios and technical solutions from the initial idea to serial production.

With our portfolios, we cater not only for general workshop needs, we are also specialists for ranges of reliable tools for rescue services and flight safety, as well as for road construction and agricultural equipment.

Our ability to draw on all important manufacturing methods enables us to realise your ideas and requirements to your complete satisfaction in every respect.





SONDERWERKZEUG- UND PROTOTYPENBAU SPECIALISED TOOLS AND PROTOTYPING

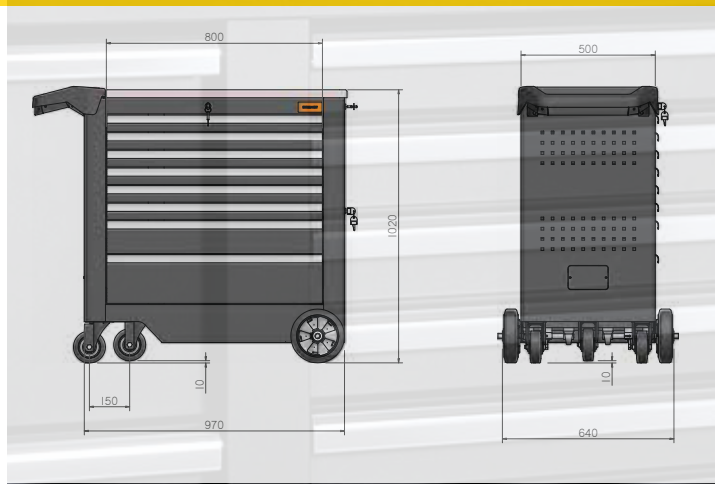

50881-6

Werkzeugkasten
„JUNIOR“

mit Sortiment, 28-tlg.
Stahlblech, lackiert

Tool box
„JUNIOR“

with 28 pcs. assortment
sheet steel, lacquered

Boîte à outils
„JUNIOR“

avec assortiment d'outils 28 pces.
en tôle d'acier, peint

Caja herramientas
„JUNIOR“

con surtido de 28 pzs.
en chapa de acero lacado



enthaltend/containing/composition/contenido

	MM 6x7/ 8x9 / 10x11 / 12x13 / 14x15 / 16x17 / 18x19 / 20x22
	MM 4,0 x 75 / 5,5 x 125 / 6,5 x 150
	PH 1 / 2
	150 - 250 V
	160 mm
	230 mm
	250 mm
	500 g
	200 mm
	200 mm
	MM 1,5/2/2,5/3/4/5/6/8/10
	TX 10/15/20/25/27/30/40/45/50
	155 mm / 6" Nonius 1/20 mm / 1/128"
	Gr. 18 mm
	3 m
	230 mm
	CE/EN 388-4131

Bestell-No./Order-No.	Art. No.	Maße · Dimensions · Medidas		
50881000600	50881-6	430 x 185 x 200 mm	8400	1

98076-08

Montage-
Werkzeugkasten, leer

5-tlg. Stahlblech,
in Hammerschlagblau

Tool box,
cantilever type, empty

5 trays, sheet steel
hammertone blue

Boîte à outils, vides

5 compartiments, en tôle d'acier
couleur bleu martelé

Caja de herramientas,
vacío

5 compartimentos, en chapa de
acero, pintada en azul



Bestell-No./Order-No.	Art. No.	Maße · Dimensions · Medidas		
98076080020	98076-08	530 x 200 x 200 mm	3250	1

508076-945

Montage-Werkzeugkasten mit Modulen

5 Module, 96-tlg.

Tool box, cantilever type with modules

5 Modules, 96 pcs.

Boîte à outils avec modules

5 Modules, 96 pces.

Caja de herramientas con módulos

5 Módulos, 96 pzs.

Heimwerker
4/10 Praxis Oberklasse
TESTSIEGER

Vertrieb: Heyco, Flemscheid
Preis: um 290
Hotline: 02191 2050
Internet: www.heyco.de

Note:

Schraubendreher:	15%	1,4	●●●●●
Schraubenschlüssel:	15%	1,1	●●●●●
Ratschen-/Bitsätze:	25%	1,5	●●●●●
Zangen:	15%	1,2	●●●●●
Bedienung (Set):	10%	1,4	●●●●●
Ausstattung:	20%	1,0	●●●●●

Bewertung: ●●●
● keine losen Teile / Austreiber
● Gewicht

Oberklasse

Heimwerker
Praxis 4/2010
Preis/Leistung: gut

1,3



M 50829-30

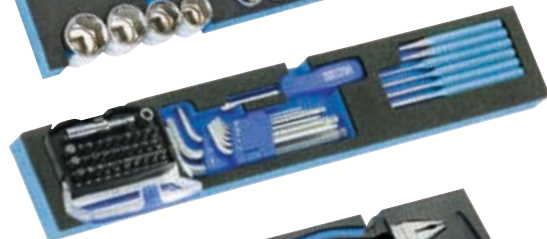

M 50829-31



M 50829-32



M 50829-33



M 50829-34



Bestell-No./Order-No.	Art. No.	Module · Modules · Módulos				
50807694500	508076-945	M 50829-30	M 50829-31	M 50829-32	14430	1
		M 50829-33	M 50829-34			

enthaltend · containing · composition · contenido →

M 50829-30



Werkzeugmodul,
21-tlg.

Tool module,
21 pcs.

Module avec outils,
21 pces.

Módulo con herramientas,
21 pzs.

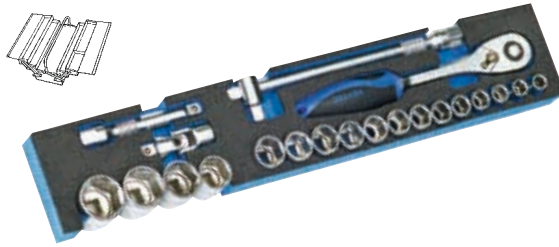

enthaltend/containing/composition/contenido

	250 mm
	250 mm
	125 mm
	MM 10/11/12/13/14/15/16/17/18/19/ 20/21/22/24/27/30/32
	75 mm

Bestell-No./Order-No.	Art. No.	Module · Modules · Módulos		
50829003083	M 50829-30	528 x 98 x 35 mm	2954	1

M 50829-31

Werkzeugmodul,
48-tlg.

Tool module,
48 pcs.

Module avec outils,
48 pces.

Módulo con herramientas,
48 pzs.



enthaltend/containing/composition/contenido

	Ø 3 x 120 mm
	Ø 3 x 150 mm / Ø 4 x 150 mm / Ø 5 x 150 mm / Ø 6 x 150 mm
	Ø 4 x 120 mm
	MM 1,5/2/2,5/3/4/5/6/8/10
	150 mm
	50833-2 (siehe Seite 36/see page 36/ voir page 36/véase página 36)

Bestell-No./Order-No.	Art. No.	Module · Modules · Módulos		
50829003100	M 50829-31	528 x 98 x 35 mm	1063	1

M 50829-32

Werkzeugmodul,
7-tlg.

Tool module,
7 pcs.

Module avec outils,
7 pces.

Módulo con herramientas,
7 pzs.



enthaltend/containing/composition/contenido

	1000 g
	300 g
	195 – 570 mm
	180 mm
	250 mm
	160 mm
	255 mm

Bestell-No./Order-No.	Art. No.	Module · Modules · Módulos		
50829003200	M 50829-32	528 x 195 x 35 mm	3040	1

M 50829-33

Werkzeugmodul,
6-tlg.

Tool module,
6 pcs.

Module avec outils,
6 pces.

Módulo con herramientas,
6 pzs.

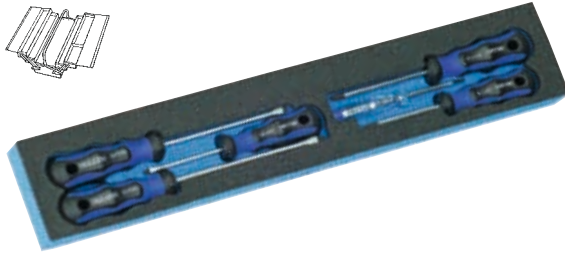

enthaltend/containing/composition/contenido

- 0,75 x 3,0 x 60 mm
- 4,0 x 75 mm
- 5,5 x 125 mm
- 6,5 x 150 mm
- PH 1 / PH 2

Bestell-No./Order-No.	Art. No.	Module · Modules · Módulos		
50829003380	M 50829-33	528 x 98 x 35 mm	483	1

M 50829-34

Werkzeugmodul,
14-tlg.

Tool module,
14 pcs.

Module avec outils,
14 pces.

Módulo con herramientas,
14 pzs.



enthaltend/containing/composition/contenido

- MM 8/10/11/12/13/14/15/
16/17/19/22/24
- 170 mm
- 5 m

Bestell-No./Order-No.	Art. No.	Module · Modules · Módulos		
50829003480	M 50829-34	528 x 98 x 35 mm	1888	1

M 50829-35

Austauschmodul
für Montage-Werkzeug-
kasten, 16-tlg.

Exchange modul
for tool box set, 16 pcs.

Module alternatif pour
boîte à outils pour
monteurs, 16 pces.

Módulo intercambiable
para caja de
herramientas, 16 pzs.



enthaltend/containing/composition/contenido

- MM 6x7/8x9/10x11/12x13/
14x15/16x17/18x19/20x22
- MM 6x7/8x9/10x11/12x13/
14x15/16x17/18x19/20x22

Bestell-No./Order-No.	Art. No.	Module · Modules · Módulos		
50829003580	M 50829-35	528 x 98 x 35 mm	1960	1

508201-762

Montage-Werkzeug-sortiment, 97-tlg.

L-BOXX® Module mit 97 Werkzeugen

- Ordentlich Aufbewahren
- Einfache Klickverbindung
- Modularer Innenraum
- Einzigartiges Mobilitätssystem
- Beliebiger Erweiterbar
- Crashesicherer Transport
- Aus schlag- und stoßfestem ABS-Kunststoff
- Ergonomisch geformten Griffe, zusätzliche seitliche Griffschalen sowie praktische Schlaufen garantieren ein flexibles und komfortables Handling
- Der Deckel ist bis 100 kg belastbar, spritzwassergeschützt
- Beladungskapazität pro Box bis zu 25 kg
- Transport der Boxen im Verbund bis 40 kg

Construction tool set, 97 pcs.

L-BOXX® Modules with 97 tools

- Provides individual options for storage
- Robust click mechanism
- Modular interior
- Expandable as desired
- Unique mobility system
- Crash Safe transport
- Made of impact and shock resistant ABS plastic
- Ergonomically shaped handles and additional side grips for flexible and convenient handling
- The lid can hold a load of up to 100 kg, spray-water protected
- Loading capacity of up to 25 kg
- Transported in bundles up to 40 kg

Assortiment d'outils d'assemblage, 97 pces.

Module L-BOXX® avec 97 outils

- Ranger proprement
- Connexion facile par simple clic
- Intérieur modulaire
- Système de mobilité unique
- Extensible si nécessaire
- Transport anti-crash
- Fabriqué en plastique ABS résistant aux chocs et aux impacts
- Poignées de formes ergonomique. Poignées latérales supplémentaires ainsi que des boucles pratiques qui garantissent une flexibilité et manipulation confortable
- Le couvercle peut tenir 100 kg et est résistant aux éclaboussures
- Capacité de chargement par boîte jusqu'à 25 kg
- Transport des boîtes en combinaison jusqu'à 40 kg



Conjunto de herramientas de montaje, 97 pzs.

L-BOXX® Módulos con 97 herramientas

- Almacenamiento ordenado
- Conexión simple
- Interior modular
- Sistema único de movilidad con posibilidad de ampliación
- Transporte seguro contra rotura
- De plástico ABS resistente
- Mangos ergonómicos, además de bandejas adicionales laterales, así como prácticas asas que garantizan un manjo flexible y confortable
- La tapa resiste pesos de hasta 100 kgs, con protección contra salpicaduras
- Capacidad de carga por conjunto hasta 25 kgs
- Transporte de las cajas en conjunto hasta 40 kgs

new



Bestell-No./Order-No.	Art. No.	Maße · Dimensions · Medidas	Module · Modules		
new 50820176200	508201-762	442 x 357 x 151 mm	50807696100 50807696200	11690	1



50876-961

Montage-Werkzeug-sortiment für L-BOXX®, 77-tlg.

Construction tool set for L-BOXX®, 77 pcs.

Assortiment d'outils d'assemblage pour L-BOXX®, 77 pcs.

Caja herramientas para L-BOXX®, 77 pzs.



Bestell-No./Order-No.

Art. No.

Maße · Dimensions · Medidas



new

50807696100

50876-961

405 x 310 x 50 mm

5910

1

enthaltend/containing/composition/contenido

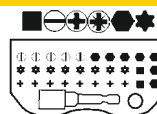

50833-2
(siehe Seite 36/see page 36/
voir page 36/véase página 36)



255 mm



250 mm



250 mm



75 mm



MM 1,5/2/2,5/3/4/5/6/8/10



200 mm



MM 8/10/11/12/13/14/
15/16/17/19/22/24



MM 10/11/12/13/14/15/16/17/
18/19/20/21/22/24/27/30/32



125 mm



230 mm

50876-962

Montage-Werkzeug-sortiment für L-BOXX®, 20-tlg.

Construction tool set for L-BOXX®, 20 pcs.

Assortiment d'outils d'assemblage pour L-BOXX®, 20 pcs.

Caja herramientas para L-BOXX®, 20 pzs.



Bestell-No./Order-No.

Art. No.

Maße · Dimensions · Medidas



new

50807696200

50876-962

405 x 310 x 40 mm

5110

1

enthaltend/containing/composition/contenido



150 - 250 V



0,8 x 4,0 x 75 mm / 1,0 x 5,5 x 125 mm /
1,2 x 6,5 x 150 mm



PH 1 / PH 2



3 m



Gr. 18 mm



1000 g

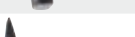

300 g

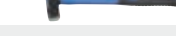

250 mm



180 mm



160 mm



195 - 570 mm

508675



Montage-Werkzeugkoffer mit Modulen, 134-tlg.

Hochwertiger ABS-Schalenkoffer mit Werkzeugtafeln und 2-K Schaumstoffeinlage (4 Module)

- Ausstattungsmerkmale:
- Made in Germany
 - Schlagfestes ABS-Material
 - Umlaufender Stoßkantenschutz
 - Hochwertige Metallschlösser
 - Stabiler und gehärteter Aluminiumrahmen
 - Ergonomischer Tragegriff
 - Drei Metallscharniere
 - Stabiler Deckelhalter
 - Getestet im Dauereinsatz bis 25 kg

Construction tool case with modules, 134 pcs.

Premium-quality ABS-Shell case with tool- and 2-K foam inlays (4 Modules)

- Features:
- Made in Germany
 - Impact-proof ABS-material
 - Circumferential abutting edge-protection
 - Premium-quality metal locks
 - Stable and hardened aluminium frame
 - Ergonomic carrying handle
 - Three metal hinges
 - Stable lid holder
 - Tested under continuous operation up to 25 kg

Coffre à outils avec modules, 134 pcs.

Boîtier ABS de haute qualité avec plateau d'outils et deux inserts en mousse 2 composants (4 Modules)

- Caractéristiques:
- Fabriqué en Allemagne
 - Matériel ABS haute résistance
 - Pare-chocs autour du coffret
 - Serrures métalliques de haute qualité
 - Cadre en aluminium stable et dur
 - Poignée ergonomique
 - Trois charnières métalliques
 - Support à couvercle robuste
 - Testé en utilisation continue jusqu'à 25 kg

Cofre de herramientas para montadores, con módulos, 134 pzs.

Maleta de plástico ABS con bandejas de herramientas y forro de dos componentes (4 Módulos)

- Características del equipamiento:
- Made in Germany
 - Plástico tipo ABS- cantos protegidos
 - Umlaufender Stoßkantenschutz
 - Cerraduras metálicas de calidad
 - Armazón robusto y templado de aluminio
 - Asa hergonómica
 - 3 bisagras metálica
 - Sujeción de la tapa reforzada
 - Probada en uso permanente hasta 25 kg



32-tlg./pcs.



25-tlg./pcs.



32-tlg./pcs.



25-tlg./pcs.



25-tlg./pcs.

enthaltend/containing/composition/contenido

- Wrenches: MM 8/10/11/12/13/14/15/16/17/19/22/24
- Gloves: Geprüft nach DIN EN 166 F
- Gloves: 9" / CE/EN 388-4131
- Screwdrivers: 150 - 250 V
- Screwdrivers: Gr. 18 mm
- Screwdrivers: 195 - 570 mm
- Screwdrivers: MM 4,0 x 75 / 5,5 x 125 / 6,5 x 150
- Screwdrivers: PH 1 / 2
- Screwdrivers: 200 mm
- Pliers: 200 mm
- Pliers: 250 mm
- Pliers: 180 mm
- Pliers: 160 mm
- Hex keys: MM 1,5/2/2,5/3/4/5/6/8/10
- Hex keys: TX 10/15/20/25/27/30/40/45/50
- Wrench: 205 mm
- Measuring tape: 3 m
- Hammer: 200 mm
- Hammer: 500 g
- Level: 230 mm
- Screwdriver: 200 mm
- Screwdriver: 200 mm
- Screwdriver: 250 mm
- Screwdriver: 250 mm
- Screwdriver: 125 mm
- Bit: MM 10/11/12/13/14/15/16/17/18/19/20/21/22/24/27/30/32
- Bit: 75 mm
- Legend:
 - R1 - R2
 - ⊖ 3,5 - 8
 - ⬠ 2 - 8
 - ⊕ PH1 - 3
 - ⊖ PZ 1 - 3
 - ⬠ TT 9 - 40
- Legend:
 - 115 mm
 - 100 mm
 - 125 mm
 - ⬠ TT 10-40
 - ⊕ PH2
 - ⬠ 5/6
 - ⬠ PZ 2
- Legend:
 - MM 4/4,5/5/5,5/6/7/8/9/10/11/12/13
 - ⊕ 3 x 120 mm
 - ⊕ 5 x 150 mm
 - ⊕ 3 x 120 mm
 - ⊕ 5 x 130 mm
 - ⊕ 12 x 130 mm
 - ⊕ 14 x 150 mm

Bestell-No./Order-No.	Art. No.	Maße · Dimensions · Medidas		
5086750000	508675	460 x 370 x 170 mm	13300	1

50807-92



Montage-Werkzeug-sortiment in Umhänge-tasche, 92-tlg.

Hochwertige Aufbewahrungstasche mit Klemmhaltesystem sowie Einsteckfächern für Werkzeuge aller Art

Ausstattungsmerkmale:

- Gepolsterter Trageriemen
- Robuster Tragegriff
- Ausklappbarer Stellfuß für sicheren Stand
- Kleinteilmagazin
- Geschütztes, gepolstertes Laptop-Fach
- Zusätzliches Fach für Dokumente

Tool assortment in shoulder bag, 92 pcs.

Premium-quality storage bag with locking system and compartments for all kinds of tools

Features:

- Cushioned carrying strap
- Robust carrying handle
- Fold-out foot for a secure stand
- Small parts magazine
- Protected, cushioned laptop-compartment
- Additional compartment for documents

Sélection de outillage en sac pour outils, 92 pcs.

Sac de rangement de haute qualité avec système de serrage, ainsi que des poches pour tous types d'outils

Caractéristiques:

- Bandoulière rembourrée
- Poignée de transport robuste
- Pli pied réglable pour plus de stabilité
- Pour petites pièces
- Protégé, compartiment rembourré pour ordinateur portable
- Compartiments à documents

Conjunto de herramientas en cartera para herramientas, 92 pzs.

Cartera de calidad, con pinzas y bolsillos para guardar herramientas de todo tipo

Características del equipamiento:

- Correa acolchada
- Asa robusta
- Pie plegable para una colocación segura
- Recipiente para piezas pequeñas
- Compartimento acolchado para lap-top
- Compartimento adicional para documentos



enthaltend/containing/composition/contenido

- 5 m
- 250 mm
- MM 8/9/10/11/13/14/17/19
- 180 mm
- 160 mm
- MM 1,5/2/2,5/3/4/5/6/8/10
- 150 - 250 V
- 300 g
- 150 mm
- 150 mm, Stahl, 10 Stk./pcs.
- Gr. 18 mm
- 195 - 570 mm
- Geprüft nach DIN EN 166 F
- 230 mm
- MM 4,0 x 75 / 5,5 x 125 / 6,5 x 150
- PH 1 / 2
- 150 mm
- R1 - R2
- 3,5 - 8
- 2 - 8
- PH 1 - 3
- PZ 1 - 3
- TT 9 - 40
- 205 mm
- 250 mm
- 125 mm
- MM 8/10/11/13/15/17/18/19/22/24
- MM 20,8

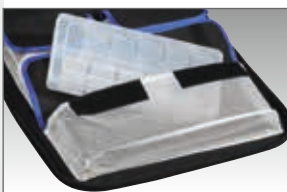
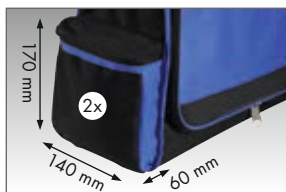
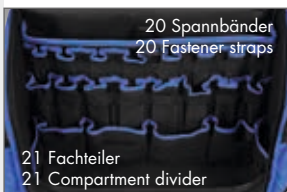

Bestell-No./Order-No.

50807892000

Art. No.

50807-92

Maße · Dimensions · Medidas

555 x 410 x 180 mm



9500



1

Rucksack für Werkzeugsortimente, leer

Hochwertiger Rucksack mit separater Innentasche für Werkzeuge aller Art

Ausstattungsmerkmale:

- Robuster Tragegriff
- Zusätzlicher Deckel zum Schutz vor Nässe
- Rutschfeste, gummierte Bodenplatte
- Sicherheitsreflektoren, robuste Aufhängeösen
- Rückenbereich ergonomisch gepolstert
- Gepolsterte Schultergurte mit Handytasche
- Netz-Außentaschen
- Seitentasche mit Fach für Visitenkarten
- Elastische Halteriemen
- Separate Werkzeugtasche
- Viele Einsteck- und Klemmhaltermöglichkeiten
- Innenfächer für Schreibunterlagen/Laptop/Tablet
- Robuste und stabile Bauform mit vielen Extras
- Hoher Tragekomfort, ergonomische Form

Backpack for tool set, empty

High quality backpack with separate inner pocket for all kinds of tools

Features:

- Robust carrying handle
- Additional wetness protection cover
- Gummed non-slip bottom slab
- Safety reflectors, robust suspension hooks
- Ergonomically cushioned back
- Upholstered shoulder belts with cell phone pocket
- Outside mesh pockets at the front and on one side
- Side pocket with business card holder
- Elastic holding straps
- Separate tool bag for convenient removal
- Multiple storage- and locking-compartments
- Interior compartments for writing pads/laptop/tablet PC
- Robust and sturdy design with various extras
- Excellent wearing comfort, ergonomic shape

Sac à dos vide pour assortiment d'outillage

Sac à dos de haute qualité avec poche intérieure séparée pour toutes sortes d'outils

Caractéristiques:

- Poignée robuste
- Couverture supplémentaire protection contre l'humidité
- Semelle caoutchoutée anti-dérapant
- Réflecteurs de sécurité, crochets de suspension robustes
- Rembourrage ergonomique
- Centures d'épaule rembourrées avec poche pour téléphone cellulaire
- Poches extérieures devant et sur un côté
- Poche latérale pour cartes de visite
- Bandoulières élastiques
- Sac à outils séparé pour enlèvement facile
- Plusieurs compartiments de stockage et de verouillage
- Compartiments intérieures pour ordinateur portable/tablette PC
- Design robuste avec de nombreux extras
- Confort excellent et forme ergonomique

Mochila para juego de herramientas, vacía

Mochila de alta calidad con bolsillo interior separado, para herramientas de todo tipo

Características del equipamiento:

- Asa robusta
- Tapa adicional de protección contra humedad
- Fondo engomado anti-deslizante
- Reflectores de seguridad, robustos ganchos de sujeción
- Espalda ergonómica acolchada
- Tirantes acolchados con bolsillo para móvil
- Bolsillos de redicilla delanteros y a un lateral
- Bolsillo lateral para guardar tarjetas de visita
- Tirantes elásticos de sujeción
- Bolsa de herramientas separada y extraíble
- Compartimentos múltiples para almacenaje
- Compartimentos interiores para anotaciones pads/laptop/tablet PC
- Diseño robusto y resistente con varios extras
- Muy comfortable para llevar, con diseño ergonómico



Bestell-No./Order-No.

Art. No.

Maße · Dimensions · Medidas



50810520000

5081052

460 x 350 x 180 mm

2500

1

5081052-9



Montage-Werkzeug-sortiment im Rucksack, 92-tlg.

Hochwertiger Rucksack mit separater Innentasche für Werkzeuge aller Art

Tool assortment in backpack, 92 pcs.

High quality backpack with separate inner pocket for all kinds of tools

Assortiment d'outils en sac à dos, 92 pcs.

Sac à dos de haute qualité avec poche intérieure séparée pour toute sortes d'outils

Juego de herramientas en mochila, 92 pzs.

Mochila de alta calidad con bolsillo interior separado para herramientas de todo tipo



YouTube



enthaltend/containing/composition/contenido

	5 m	
	250 mm	
	180 mm	
	180 mm	
	150 - 250 V	
	300 g	
	150 mm	
	10 Stk./pcs.	
	Gr. 18 mm	
	195 - 570 mm	
	230 mm	
	205 mm	
	250 mm	
	MM 8/9/10/11/ 13/14/17/19	
	MM 1,5/2/2,5/ 3/4/5/6/8/10	
	Geprüft nach DIN EN 166 F	
	MM 4,0 x 75 / 5,5 x 125 / 6,5 x 150	
	PH 1 / 2	
	150 mm	
	R1 - R2	PH1 - 3
	3,5 - 8	PZ 1 - 3
	2 - 8	TT 9 - 40
	125 mm	
	MM 8/10/11/13/ 15/17/18/19/22/24	
	MM 20,8	

Bestell-No./Order-No.	Art. No.	Maße · Dimensions · Medidas		
50810529200	5081052-9	460 x 350 x 180 mm	10600	1

5081052-5

**Dachdecker-Sortiment
im Rucksack,
50-tlg.**

Hochwertiger Rucksack
mit separater Innentasche
für Werkzeuge aller Art

**Slater assortment
in backpack,
50 pcs.**

High quality backpack
with separate inner pocket
for all kinds of tools

**Assortiment pour couvreur
dans sac à dos,
50 pcs.**

Sac à dos de haute qualité avec
poche intérieure séparée pour
toute sortes d'outils

**Juego de herramientas
para trabajos en tejados,
50 pzs.**

Mochila de alta calidad con
bolsillo interior separado para
herramientas de todo tipo



YouTube



enthaltend/containing/composition/contenido



5 m



195 - 570 mm



230 mm



200 mm



260 mm

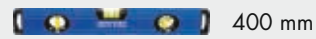

400 mm



200 mm



200 mm



200 mm / 8"



400 mm



Geprüft nach
DIN EN 166 F

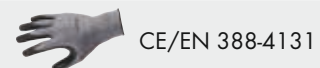

CE/EN 388-4131



Gr. 18 mm



600 g



300 mm / 11,8"



17+22er
Zahnung
teeth per inch



315 mm
19 x 22



Bestell-No./Order-No.

50810525000

Art. No.

5081052-5

Maße · Dimensions · Medidas

460 x 350 x 180 mm



8100



1

50879
50880
50882
50885
50886

Drehmomentschlüssel mit Hebelumschaltknarre

Chrom-Vanadium
in Kunststoffbox

Torque wrenches with reversible ratchet

Chrome-Vanadium
in plastic box

Clé dynamométrique avec cliquet réversible

Chrome-Vanadium
en coffret plastique

Llaves dinamométrica con carraca reversible

Cromo Vanadio
en estuche de polipropileno

1/4"
3/8"
1/2"
3/4"



Impact-Steckschlüssel-Einsätze finden Sie auf den Seiten 111-112
Impact sockets you will find on pages 111-112

Hebelumschaltknarre
mit Auswerferstift zum Schnellösen der Steckverbindung

Lever type reversible ratchet
with quick release ejector button

Cliquet réversible
tige d'éjection pour libérer rapidement l'outil du cliquet

Carraca reversible
con expulsor para separación instantánea de vasos y accesorios

Gut einstellbare, deutlich lesbare Skala
Clearly visible scale
Echelle de graduation facilement ajustable et très lisible
Escala nitidamente legible, de fácil ajuste

Verriegelung des eingestellten Drehmomentwertes
Locking of set torque
Verrouillage du couple sélectionné
Bloqueo del par de apriete seleccionado

Rutschfester Drehgriff für sichere Handhabung und zum Einstellen des Drehmomentwertes
Nonskid turning handle for safe handling and precise adjustment of torque value
Poignée tournante anti-glisse pour une prise en main sûre et pour régler le couple
Empuñadura giratoria para un manejo seguro y para ajustar el par de apriete

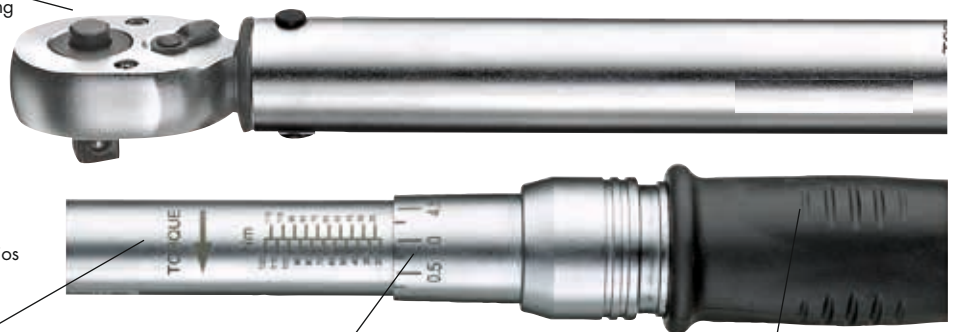

Bestell-No./Order-No.	Art. No.	■	Nm	Ø mm	g	📦
50879000080	50879	1/4"	3-15	190-210	290	1
50880000080	50880	1/4"	4-20	300-320	865	1
50882000080	50882	3/8"	20-120	405-435	1665	1
50885000080	50885	1/2"	40-200	485-510	2020	1
50886000080	50886	3/4"	100-600	1035-1052	5047	1

508201-614

Drehmomentschlüssel,
Festwert 140 Nm

Torque Wrench,
140 Nm

Cle dynamometrique
valeur, 140 Nm

Llave dinamométrica fija
de 140 Nm

1/2"

new



Bestell-No./Order-No.	Art. No.	Nm	CL mm	g	
50820161483	508201-614	140	410	1021	1

50895-1

Einstecknarre

Chrom-Vanadium, verchromt
umschaltbar, 72 Zähne

Reversible
ratchet heads

Chrome-Vanadium, chromium plated
with reversible ratchet, 72 teeth

Cliquet à
emmanchement

Chrome-Vanadium, chromées avec
cliquet réversible, 72 dents

Cabezal
de carraca

Cromo Vanadio, cromada con
carraca reversible, 72 dientes

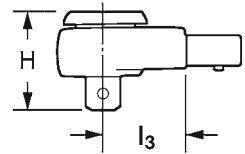

Bestell-No./Order-No.	Art. No.	■	L2 mm	D mm	H mm	für • for pour • para	g	
50895100080	50895-1	1/2"	5,9	6,5	11,1	50895	40	1

50895-31

Einsteckmaulschlüssel

Chrom-Vanadium

Open ended jaw wrench
insert tools

Chrome-Vanadium

Clé à fourche à
emmanchement

Chrome-Vanadium

Llave de boca abierta

Cromo Vanadio

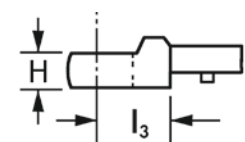
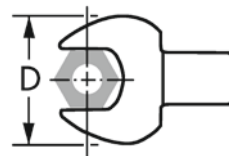

Bestell-No./Order-No.	Art. No.	MM	L3 mm	D mm	H mm	für • for pour • para	g	
50895311380	50895-31	13	25,0	30,0	7,0	50895	125	1
50895311480	50895-31	14	25,0	32,0	7,0	50895	130	1
50895311780	50895-31	17	25,0	37,0	9,0	50895	130	1
50895311880	50895-31	18	25,0	39,0	9,0	50895	145	1
50895311980	50895-31	19	25,0	41,0	9,0	50895	145	1
50895312280	50895-31	22	25,0	47,0	11,0	50895	165	1
50895312480	50895-31	24	25,0	51,0	11,0	50895	170	1
50895312780	50895-31	27	32,5	58,5	13,0	50895	215	1
50895313080	50895-31	30	32,5	63,0	13,0	50895	245	1

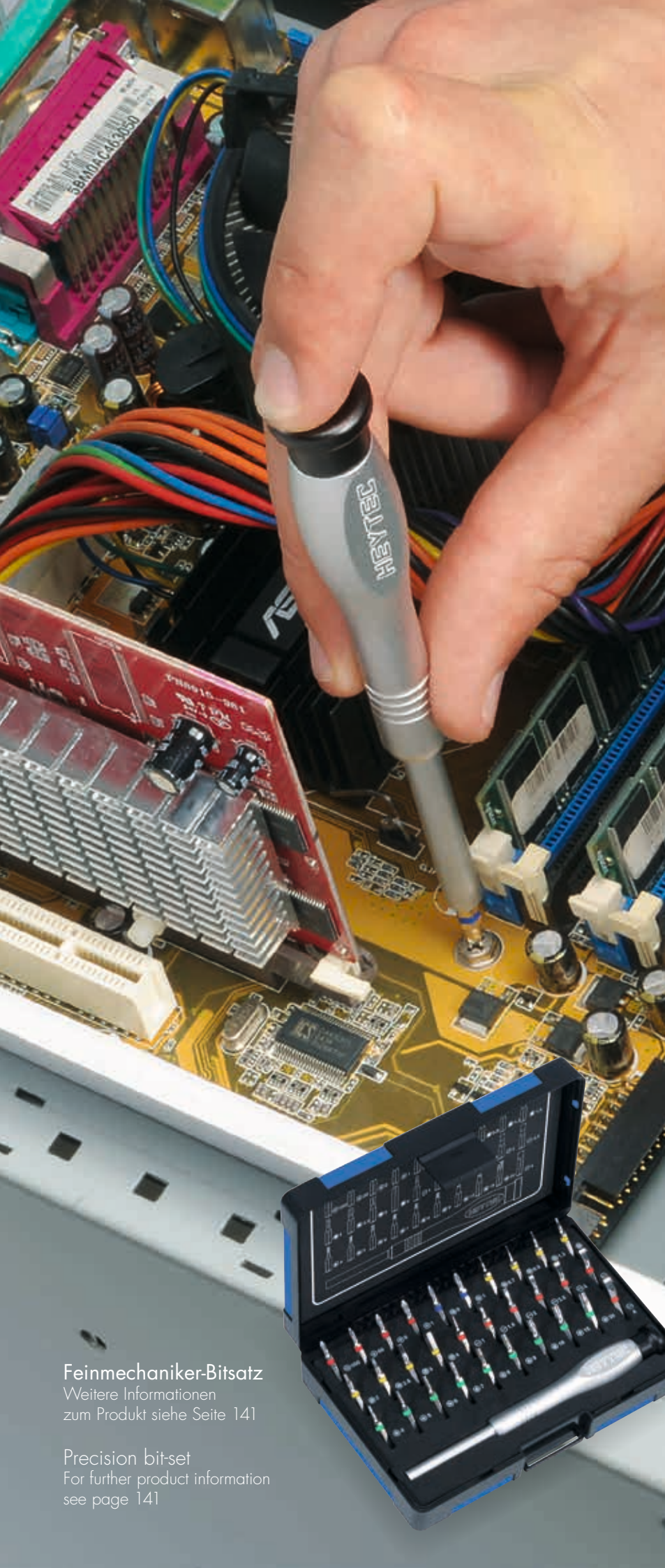

100% Kundenzufriedenheit

So urteilen unsere Anwender:

„Der Kasten ist in jeder Hinsicht Oberklasse, der Griff modisch aber gut. Ich würde den Artikel jederzeit wieder kaufen und kann ihn mit bestem Gewissen empfehlen.“

„Ein Qualitätsprodukt mit sehr gutem Preis-Leistungs-Verhältnis.“

„Habe gleich nach Erhalt den ersten Einsatz getestet. Bits sind gut und sauber verarbeitet und das Griffstück liegt ebenfalls sehr gut in der Hand. Macht einen wertigen Eindruck.“

„Warum können nicht mehr Hersteller ihre Produkte mit Augenmerk auf Qualität und Langlebigkeit planen? Dieses Set ist einfach super verarbeitet!“

100% Customer satisfaction

Here´s what our customers say:

„In every respect, this is a premium quality set. The grip is trendy but well designed. I can highly recommend this set and would surely buy it again.“

„A premium quality product offering high value for money.“

„I put the set to test immediately after I had received it. Bits are well finished doing a great job. The handle lies well in your hand, too. Generally, this set leaves an impression of high quality.“

„Why can't other tool makers design their products with a focus on quality and longevity? This set is really well built!“

Feinmechaniker-Bitsatz
Weitere Informationen
zum Produkt siehe Seite 141

Precision bit-set
For further product information
see page 141

Radwechsel-Werkzeug-satz, 8-tlg.

Für den schnellen und einfachen Radwechsel am PKW, zur Aufbewahrung in der Ersatzradmulde im Kofferraum.

- Drehmomentschlüssel, Festwert 140 Nm, 1/2" - Antrieb
- Extra lange Steckschlüsseinsätze, Chrom-Vanadium Stahl
- Aufbewahrungsbox leer, für Felgenschloss/Radschrauben
- Umsteckschraubendreher
- Lichtstreifen 18 LED mit Schalter, spritzwassergeschützt
- 4 Batterien 1,5 V AA inklusive
- Sicherheitsreflektor, beidseitig
- Integriertes Kniebrett
- Batteriefach rückseitig, spritzwassergeschützt
- Hochwertiger 2-K Schaumstoff

Wheel changing tool set, 8 pcs.

For quick application to remove a tyre, insert for storage in the trunk.

- Fixed torque wrench, 140 Nm, 1/2" drive
- Extra deep Chrome Vanadium sockets
- Empty storage box for rim lock/wheel bolt
- Reversible screwdriver
- Light pad with 18 LED, splash-proof
- 4 batteries 1.5 V AA included
- Reflective strips on front/back side
- Integrated kneeboard
- Battery compartment on the back, splash-proof
- High grade 2 components foam

Kit démontage de roues, 8 pces.

Kit pour changement rapide et facile de roues de voitures.

- Clé dynamométrique, 140 Nm, 1/2"
- Douilles extra-longues Chrome Vanadium
- Boîte de rangement vide pour verrouillage ou vis
- Tournevis réversible, plat et cruciforme
- Bande lumière avec 18 LED, résistant à l'eau
- 4 batteries AA, 1.5 V inclus
- Bandes réfléchissantes des deux côtés
- L'emballage est également une mousse pour les genoux
- Compartiment à piles sur le dos, résistant à l'eau

Juego de herramientas para cambio de rueda, 8 pzs.

Facilita un cambio rápido de neumáticos, para guardar en el maletero.

- Llave dinamométrica, 140 Nm, cuadrado 1/2"
- Llaves de vaso extra largas, de Chromo Vanadio
- Caja de almacenamiento vacía, para cerradura de llanta / tornillos de rueda
- Destornillador reversible
- Tira luminosa con 18 LED, impermeable
- 4 pilas 1.5 AA incluidas
- Tiras reflectantes delanteras y traseras
- Protección de rodilla integrada
- Compartimento de batería en la parte trasera, impermeable
- Poliestileno de 2 componentes de alta calidad

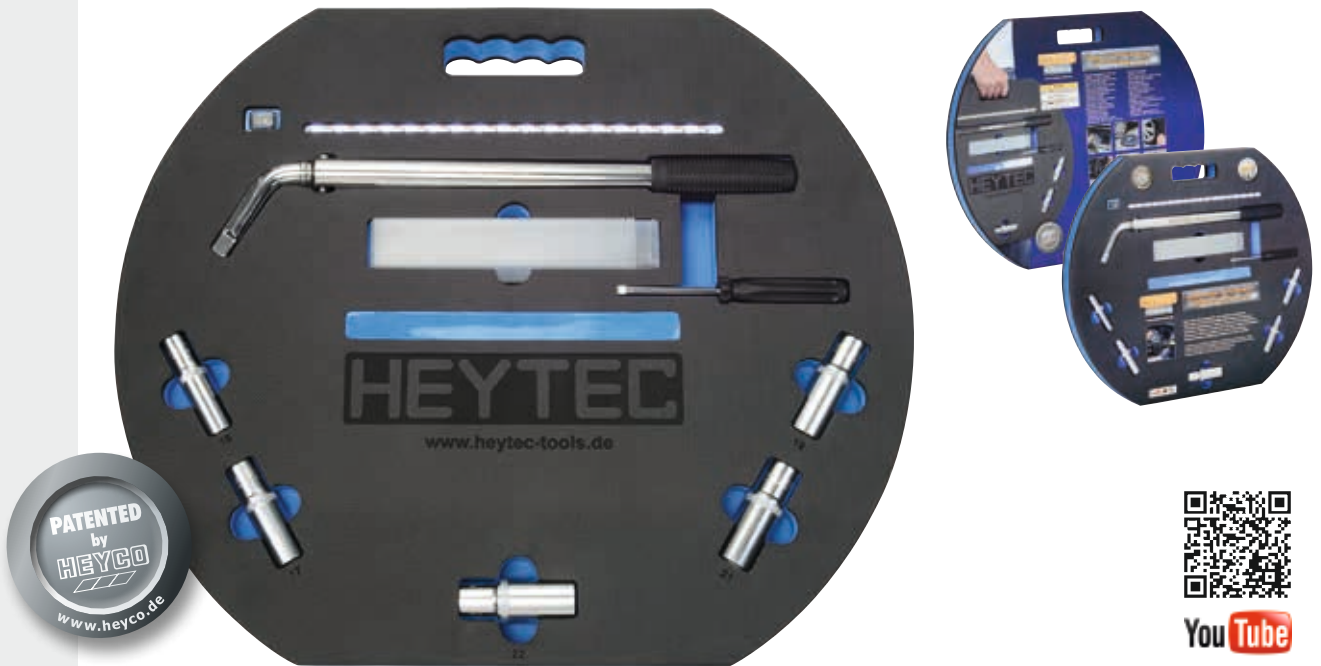

enthaltend/containing/composition/contenido			
	CL ⇄ 410 mm	Drehmomentschlüssel / Torque wrench, 140 Nm	
	CL ⇄ 75 mm	MM 15/17/19/21/22	
	CL ⇄ 160 mm	+	
	CL ⇄ 200 mm	Radmutternbox / Wheel nut box	

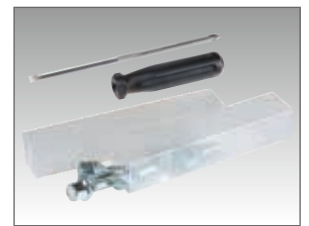

Bestell-No./Order-No.	Art. No.	Maße · Dimensions · Medidas		
50820160900	5082016	L 550 x B 470 x H 40 mm	2500	1

5086300-B 5086300-19-B



Impact-Steckschlüssel

Chrom-Molybdän-Stahl, mit Kunststoffhülse und Kunststoffeinsatz zum Schutz von Alufelgen. Mit Kugelfangrinne und Bohrung, gefederte Magnethalterung für Hand- und Schlagschrauberbetrieb.

Impact sockets

Chrome-molybdenum steel for protection of alloy wheels, with ball retaining groove and bore hole for manual operation or impact and power driven tools.

Douilles impact

Acier au Chrome-Molybdène, avec gaine plastique de protection des jantes en aluminium, Avec élément de retenue de la bille, pour utilisation à main et à choc.

Llaves de vaso de impacto

Acero al cromo molibdeno, con protectores de plástico para no dañar llantas de aluminio, con ranura y agujero para su fijación, para apriete manual y a máquina.

5086300-B



- Magnetische Aufnahme
- Sicherer Halt für die gelöste Mutter
- Federnder Einsatz
- Maximaler Formschluss durch Längenanpassung

Bestell-No./Order-No.	Art. No.	MM	mm	g	
50863001730	5086300-B	17	85	216	1
50863001930	5086300-B	19	85	227	1
50863002130	5086300-B	21	85	250	1
50863002230	5086300-B	22	85	250	1

5086300-19-B



Bestell-No./Order-No.	Art. No.	MM	mm	g	
50863191730	5086300-19-B	17	150	375	1
50863191930	5086300-19-B	19	150	400	1

5086300 - 5086300-19



Impact-Steckschlüssel

Chrom-Molybdän-Stahl, mit Kunststoffhülse und Kunststoffeinsatz zum Schutz von Alufelgen. Mit Kugelfangrinne und Bohrung, für Hand- und Schlagschrauberbetrieb.

Impact sockets

Chrome-molybdenum steel for protection of alloy wheels, with ball retaining groove and bore hole for manual operation or impact and power driven tools.

Douilles impact

Acier au Chrome-Molybdène, avec gaine plastique de protection des jantes en aluminium, Avec élément de retenue de la bille, pour utilisation à main et à choc.

Llaves de vaso de impacto

Acero al cromo molibdeno, con protectores de plástico para no dañar llantas de aluminio, con ranura y agujero para su fijación, para apriete manual y a máquina.

5086300



Bestell-No./Order-No.	Art. No.	MM	mm	g	
50863001760	5086300	17	85	216	1
50863001960	5086300	19	85	227	1
50863002160	5086300	21	85	255	1

5086300-19



Bestell-No./Order-No.	Art. No.	MM	mm	g	
50863191760	5086300-19	17	150	375	1
50863191960	5086300-19	19	150	400	1
50863192160	5086300-19	21	150	440	1

5086300-3



Impact-Steckschlüsselsatz

3-tlg. mit Kunststoffhülse in Box

Impact sockets set

3 pcs. in box, with plastic sleeves and plastic inserts

Composition de douilles impact

3 pièces avec gaine plastique en boîte

Llaves de vaso de impacto

De 3 piezas, con protectores de plástico, en estuche



Bestell-No./Order-No.	Art. No.	MM	mm		
50863000300	5086300-3	17/19/21	85	820	1

5086300-19-3

Impact-Steckschlüsselsatz

6-tlg. mit Kunststoffhülse in Box, extra lang für Tiefbettfelgen, SW 17, 19, 21 mm + 3 Ersatz Kunststoffschonhülsen

Impact sockets set

Set of 6 pcs. in box, including 3 spare sleeves, extra long for full drop center rims, 17, 19, 21 mm

Composition de douilles impact

6 pièces avec gaine plastique en boîte, extra-longues pour jantes à base creuse SW 17, 19, 21 mm et 3 gaines plastique de rechange

Llaves de vaso de impacto

De 6 piezas, con protectores de plástico, en estuche, extra largas para llantas con asientos de tornillo profundos, bocas exagonales de 17, 19 y 21 mm, con 3 protectores de plástico de recambio



Bestell-No./Order-No.	Art. No.	MM	mm		
50863190300	5086300-19-3	17/19/21	150	1460	1

50253

Greifzange

Mit durchgestecktem Gleitgelenk, Chrom-Vanadium, lackiert, teilweise geschliffen, Griffe kunststoffbeschichtet

Multigrip plier

With box joints, Chrome-Vanadium, lacquered, partly ground, plastic coated handles

Pincés multiprise

Charnière entrepassée et glissière, Chrome-Vanadium, laquées partiellement meulée, branches gainées plastique

Tenaza de abertura múltiple

Unión machihembrada, Cromo Vanadio, pintada, parcialmente pulida, mangos plastificados



Bestell-No./Order-No.	Art. No.	mm		
50253320834	50253	250	385	1

**5081330/
5081331**

Eckrohrzangen

Kopf induktiv gehärtet und poliert, pulverbeschichtet, Rolle unverlierbar

Elbow pipe wrenches

Face inductive hardened and polished, powder coated, roll captive

Clé en tube coudée

Tête trempée par induction et polie, revêtement par pulvérisation, bille imperdable

Llaves para apretar los tubos en ángulos

Cabezal inductivo templado y pulido, con recubrimiento pulvimetalúrgico, rollo imperdible



Bestell-No./Order-No.	Art. No.	Ø mm	Ø"	g	
50813301020	5081330	320	1	800	1
50813301520	5081330	425	1.1/2	1450	1
50813311020	5081331	320	1	760	1
50813311520	5081331	425	1.1/2	1450	1

5081200

Kombinationszange, DIN ISO 5746

Kopf geschliffen und lackiert, Griffe mit 2-K Kunststoffhandschutz, Schneide für mittelharten Draht

Combination plier, DIN ISO 5746

Head ground and lacquered with 2K plastic handle cutting edges for middlehard wire

Pince universelle, DIN ISO 5746

Chromées et laquées branches gainées plastique à 2 composantes, pour fil de dureté moyenne

Alicate universal, DIN ISO 5746

Cabeza amolada y barnizada, mangos con funda de plástico 2K, cortante para alambre semi-duro



Bestell-No./Order-No.	Art. No.	Ø mm	g	
50812001842	5081200	180	260	1

5081208

Flachrundzange, gerade, DIN ISO 5745

Kopf geschliffen und lackiert, Griffe mit 2-K Kunststoffhandschutz, Schneide für mittelharten Draht

Snipe nose plier, straight, DIN ISO 5745

Head ground and lacquered with 2K plastic handle cutting edges for middlehard wire

Pince à becs demi-ronds, droits, DIN ISO 5745

Chromées et laquées branches gainées plastique à 2 composantes, pour fil de dureté moyenne

Alicate de radio, recto, DIN ISO 5745

Cabeza amolada y barnizada, mangos con funda de plástico 2K, cortante para alambre semi-duro



Bestell-No./Order-No.	Art. No.	Ø mm	g	
50812082042	5081208	200	185	1

5081209

Flachrundzange,
45° abgewinkelt,
DIN ISO 5745

Kopf geschliffen und lackiert, Griffe
mit 2-K Kunststoffhandschutz,
Schneide für mittelharten Draht

Snipe nose plier,
45° angle,
DIN ISO 5745

Head ground and lacquered
with 2K plastic handle
cutting edges for middlehard wire

Pince à becs demi-ronds,
coudés à 45°,
DIN ISO 5745

Chromées et laquées branches
gainées plastique à 2 composantes,
pour fil de dureté moyenne

Alicate de radio,
curvo a 45°,
DIN ISO 5745

Cabeza amolada y barnizada,
mangos con funda de plástico 2K,
cortante para alambre semi-duro



Bestell-No./Order-No.	Art. No.	CL Ø mm	g	g
50812092042	5081209	200	185	1

5081212

Kraftseitenschneider,
DIN ISO 5749

Spezialstahl, Kopf geschliffen
und lackiert, Griffe mit 2-K
Kunststoffhandschutz, Schneide für
harten Draht (Piano Draht)

Diagonal cutting nipper,
DIN ISO 5749

Head ground and lacquered
with 2K plastic handle
cutting edges for piano wire

Pincès coupantes
diagonales
DIN ISO 5749

Acier spécial, chromées et laquées
branches gainées plastique à
2 composantes, pour fil dur
(corde à piano)

Alicate cortalambre
DIN ISO 5749

Acero especial, Cabeza amolada
y barnizada, mangos con funda
de plástico 2K, cortante para
alambre cuerda de piano

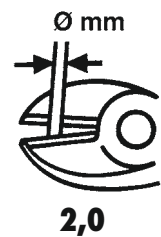

Bestell-No./Order-No.	Art. No.	CL Ø mm	g	g
50812121842	5081212	180	255	1

5081213

Seitenschneider,
schwedische Form,
DIN ISO 5749

Kopf geschliffen und lackiert, Griffe
mit 2-K Kunststoffhandschutz,
Schneide für mittelharten Draht

Diagonal cutting nipper,
swedish pattern,
DIN ISO 5749

Head ground and lacquered
with 2K plastic handle
cutting edges for middlehard wire

Pincès coupantes
diagonales modèle
suédois, DIN ISO 5749

Chromées et laquées branches
gainées plastique à 2 composantes,
pour fil de dureté moyenne

Alicate cortalambre
modelo sueco,
DIN ISO 5749

Cabeza amolada y barnizada,
mangos con funda de plástico 2K,
cortante para alambre semi-duro



Bestell-No./Order-No.	Art. No.	CL Ø mm	g	g
50812131642	5081213	160	220	1

5081241

Kneif-/Rabitzzange, DIN ISO 9242A

Mattschwarz lackiert
mit polierten Backen, tauchisoliert
Schneide für mittelharten Draht

Tower pincers, DIN ISO 9242A

Satin black lacquered finish with
polished jaws, plastic coated
handles

Tenaille, DIN ISO 9242A

Laquée noir mat
avec becs polis, poignées isolées

Tenaza rusa, DIN ISO 9242A

Pintada en negro mate,
bocas pulidas, mangos
plastificados



Bestell-No./Order-No.	Art. No.	CL Ø mm	g	
50812412213	5081241	230	330	1
50812412513	5081241	250	410	1

5081242

Kantenzange, DIN 5241

Mattschwarz lackiert
mit polierten Backen, tauchisoliert

End cutting plier, DIN 5241

Satin black lacquered finish with
polished jaws, plastic coated
handles

Tenaille de menuisier, DIN 5241

Laquée noir mat
avec becs polis, poignées isolées

Tenaza de corte frontal, DIN 5241

Pintada en negro mate,
bocas pulidas, mangos
plastificados



Bestell-No./Order-No.	Art. No.	CL Ø mm	g	
50812422013	5081242	200	430	10

5081670

Profi Universal-Schere

- Edelstahl Klingen mit feinsten Sägezahnprofilierung für hohe Standzeiten und beste Schneideergebnisse
- Ergonomischer 2-K Griff
- Einhändige Verriegelung
- Abisolierung von Drähten mit den Durchmessern 1 mm², 1,5 mm², 2 mm²
- Ideal geeignet zum Schneiden von dünnen Blechen, Drähten, Kunststoffen, Leder und Teppichen
- Einkerbung in der Klinge erleichtert das Schneiden von runden Materialien
- Automatische Öffnung durch innenliegende Feder

Professional universal scissors

- Stainless steel blades with finest saw tooth tread design for high durability and best cutting results
- Ergonomic 2-K handle
- Single-handed locking
- Stripping of wires with 1.0 mm², 1.5 mm², 2.0 mm² wire cross section
- Ideal for cutting thin sheets of metal, wires, plastics, leather and carpets
- A notch in the blade simplifies cutting of round materials
- Automatic opening by internal spring

Ciseaux universels professionnels

- Lame en acier inoxydable avec dents de scie très fin pour une longue vie et meilleurs résultats de coupe
- Poignée ergonomique à deux composants
- Blocage d'une seule main
- Dénudage des fils d'un diamètre de 1 mm², 1,5 mm², 2 mm²
- Idéal pour la découpe de tôles légers, les fils, les plastiques, le cuir et les tapis
- Entaille dans la lame facilite la coupe de matériaux ronds
- Ouverture automatique par ressort interne

Tijera universal profesional

- Hojas de acero inoxidable con perfil dentado para alta resistencia y perfectos cortes
- Mango ergonómico de dos componentes
- Bloqueo a una sola mano
- Pelar cables con diámetros de 1 mm², 1,5 mm², 2 mm²
- Perfecto para cortar chapas delgadas, alambres, plásticos, cuero y alfombras
- Redondez en la hoja para facilitar corte de materiales redondos
- Apertura automática por muelle incorporado

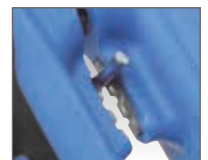

Bestell-No./Order-No.	Art. No.	CL Ø mm	g	
50816700800	5081670	200	180	1